

# Euro-2100TE

User manual (Swedish)

version 1.2



This manual was not subject to any language revision.  
This manual cannot be copied or otherwise forwarded without editor's consent.

All rights reserved © 2011, Elcom s. r. o.

# TABLE OF CONTENTS

<b>INTRODUCTION</b> .....	9
Important.....	10
Basic definitions.....	11
Logo.....	11
Department.....	11
Tax level.....	11
Sales units.....	12
Connection between departments and PLUs.....	12
Report.....	12
Bar code.....	12
System flags.....	13
Cumulated totals (Grand totals).....	13
Concepts defining the launch of the euro currency, or payment in a foreign currency.....	13
Conversion rate.....	13
Dual display.....	13
Dual cash circulation.....	14
Primary currency.....	14
Dual currencies.....	14
Mix&Match discount group's specification.....	14
<b>CASH REGISTER CHARACTERISTICS</b> .....	15
Parts of the cash register, basic parameters.....	16
Peripheral devices.....	18
THE Euro-2100TE keyboard.....	20
Names and functions of electronic cash register keys.....	20
electronic cash register displays description.....	22
Cashier display description.....	22
Customer display description.....	22
Modes switching.....	22
Paper ribbons instalation.....	24
Usage and storage of thermal paper.....	24
Calculator feature description.....	25
Implemented functionality.....	25
Keyboard operation.....	25
Calculator display.....	25
<b>PROGRAMMING MANUAL</b> .....	27
Initialization.....	28
Recommended procedure for the Euro-2100TE programming.....	29
The menu in Programming mode.....	29
List with items in the P mode menu.....	29
Initial programming of system flags.....	30
System flags correction.....	30
System flags values print out.....	30
Flag 1 - Number of decimal places, method of rounding, TAX system.....	30
Flag 2 - TAX printing, number of logo lines, blank lines.....	31
Flag 3 - Receipt consecutive number, cash register number.....	31
Flag 4 - Required operations.....	31
Flag 5 a) - Communication with PC and payment terminal.....	32

Flag 5 b) - Scanner and scales configuration.....	32
Flag 5 c) - External RS-485 converter settings.....	33
Flag 5 d) - Clean cash communication port settings.....	33
Flag 6 - Printing mode settings.....	33
Flag 7 - Limit and value of the percent add-on.....	34
Flag 8 - Limit and value of the percent discount.....	34
Flag 9 - Time setting.....	34
Flag 10 - Date setting.....	34
<b>Extended flags programming.....</b>	<b>34</b>
First extended flag.....	35
Second extended flag.....	35
Third extended flag.....	35
Fourth extended flag.....	36
Fifth extended flag.....	36
Sixth extended flag.....	37
Seventh extended flag.....	37
Eight extended flag.....	37
Printing of the extended flag values.....	37
<b>Tax rates programming.....</b>	<b>38</b>
Correction of the tax level values.....	38
Printing of the programmed tax values.....	38
Programming of organization ID.....	38
<b>PROGRAMMING OF TOP AND BOTTOM TEXT LOGO.....</b>	<b>38</b>
Correction of the text logo lines.....	39
Printing the programmed logo lines.....	39
<b>Receipt graphic logo programming.....</b>	<b>39</b>
<b>Cashiers programming.....</b>	<b>40</b>
Correction of cashiers values.....	41
Printing of cashiers values.....	41
<b>Function texts programming.....</b>	<b>41</b>
Correction of function texts.....	42
Function texts print out.....	42
<b>Departments programming.....</b>	<b>42</b>
Departments correcting.....	43
Department values print out.....	44
<b>Sale units programming.....</b>	<b>44</b>
Programmed sale units correcting.....	44
Sale unit settings print out.....	44
<b>PLU WITH A SECOND PRICE AND TAX VALUE PROGRAMMING.....</b>	<b>45</b>
Setting up the bar-code scanner.....	47
Quick PLU price programming.....	48
Quick PLU stock programming.....	48
Correction of programmed PLUs.....	49
Programmed PLUs print out.....	49
Programming of the Mix&Match discount system.....	49
<b>PROGRAMMING OF THE EURO CURRENCY.....</b>	<b>50</b>
Getting information about the actual Euro phase.....	50
Default phase - using the main currency and a foreign currency.....	50
First Euro phase - the start of dual display.....	51
Second Euro phase - dual currency circulation.....	51
Third Euro phase.....	53
<b>Entering texts into the electronic cash register.....</b>	<b>53</b>

Programming layout of the functional keyboard .....	54
Programming of the programmable keyboard keys .....	56
The key function deleting .....	57
Printing of the programmed key name .....	57
Printing of the programmed key function .....	57
Printing of the settings for all keys .....	57
<b>OPERATION IN REGISTRATION MODE.....</b>	<b>59</b>
Recommended procedures at the beginning of the day.....	60
Status and functions that are required to know before the beginning of registration .....	60
Error warning: the Clear key .....	60
Cashier log in: the Password key .....	60
Cashier log out: the Password key .....	60
Finish sale with cash, check and credit payment method .....	60
Samples of basic registration procedures .....	61
Registration using departments .....	62
Basic registration using departments .....	63
Registration using departments with price entry from keyboard .....	63
Registration using departments with pre-programmed price .....	64
Registering multiple items using departments .....	64
Items multiplying during registration using departments .....	65
Registering fractions of items using departments .....	65
Double multiplication of items during registration using departments .....	66
Single item sales using departments .....	66
PLU registration.....	67
Basic PLU registration .....	67
Multiplication in PLU registration.....	68
Individual PLU registration .....	68
Overwriting the pre-programmed PLU price.....	68
Fractional PLU registration .....	69
Double multiplication in PLU registration .....	69
Linked PLUs registration.....	69
Quick PLU programming during sale .....	69
Use of Mix&Match discounts during a sale .....	70
Selling a PLU with a second price:.....	72
Registration with customer number .....	72
Registration using bar-codes .....	72
Weight entry by electronic scales .....	73
Connection of two electronic scales .....	73
Registration using an external PC keyboard .....	73
Corrections .....	74
Clearing .....	74
Voidance .....	74
Percentage and value surcharge .....	75
Percent surcharge .....	76
Percent discount .....	76
Value discount.....	77
Value surcharge and discount .....	77
Percentage and value surcharge.....	77
PLU price lookup .....	77
Quick PLU information lookup.....	77
Reference number or customer number printing .....	78

Received on account .....	78
Paid out (cash or cheque) .....	78
Refunds .....	79
Non-financial PLU movements .....	80
<b>ACCOUNTING DURING THE EURO PHASES .....</b>	<b>81</b>
Use of a foreign currency .....	82
The first Euro phase - dual currency display .....	83
The second Euro phase .....	83
Payment in second Euro phase .....	84
The third Euro phase .....	85
Completion of dual display of informational currency conversion .....	85
<b>REPORTS .....</b>	<b>87</b>
How to print out reports .....	88
Generated reports .....	88
Reports contents .....	88
Report menu .....	88
Department report .....	89
PLU report .....	89
PLU stock report .....	90
Financial report .....	90
Cashier report .....	91
Total daily "X" report .....	91
Periodical "X" report .....	91
Total daily "Z" report .....	91
Periodical "Z" report .....	91
Hours daily report .....	91
Hours periodical report .....	92
Combined report .....	92
Electronic journal and sale data .....	92
How to print "X" reports .....	92
Samples of "X" reports .....	94
How to print "Z" reports .....	96
Samples of "Z" reports .....	96
How to erase text electronic journal .....	99
PC sale data .....	99
<b>EURO2A SOFTWARE.....</b>	<b>103</b>
<b>OPTIONAL ELECTRONIC CASH REGISTER ACCESSORIES .....</b>	<b>105</b>
Cash drawers .....	106
Electronic scales .....	106
Bar-code scanners .....	106
Metrologic MS-5145 ECLIPSE .....	106
Metrologic MS-6720 .....	106
Metrologic Orbit MS-7120 .....	107
Metrologic MS-9520 Voyager .....	107
External keyboard .....	107
Optional internal battery .....	107
External battery box .....	107
External journal downloader .....	107
LAN connection options .....	108
New features of Elcom cash registers .....	108

---

<b>HELPFUL ADVICE</b> .....	109
Information and error messages .....	110
What to do in case of power failure?.....	113
Power failure .....	113
Failures of electronic cash register as a result of interference in power network .....	113
Signalization of internal accumulator conditions.....	113
Self tests .....	113
Self-test of the electronics and display.....	114
Self-test of the printer .....	114
Self-test of the keyboard .....	114
Self-test of the keyboard II. ....	114
Keyboard test in P Mode.....	115
<b>SERVICE CODES OF THE electronic cash register</b> .....	115







# ***INTRODUCTION***

ELCOM company wishes to thank you for the purchase of the Euro-2100TE. Please read the instructions to become familiar with its functions and operations before you start to operate this equipment. Keep this manual for future use. It will help you solve most problems encountered in operating the Euro-2100TE.

## **IMPORTANT**

- Do not leave appliance unattended.
- Install the cash register in a place where it will not be exposed to direct sunlight, unusual temperature changes (under 0 °C and above 45 °C) or high humidity. Installation in such places could result in damage to both the casing and electrical components.
- If internal accumulator is present (optional):
  - Before first use leave the cash register turned on connected to external charger for at least eight hours to charge the internal accumulator.
  - It is strongly recommended to start battery charging after battery discharge signal to ensure long operating life and preservation of battery capacity.
  - During the cash register battery recharging, the cover can increase its temperature. We do not recommend to place the cash register near flammable materials.
  - If the external adapter is connected to the cash register, the internal accumulator is charged even when the cash register is turned off.
- After transporting the unit from a cold environment to a warm one and reversal, do not turn the cash register on for a minimum of 20 minutes in order to give all components time to adjust to the new temperature conditions.
- Person having wet hands should not operate the cash register. Water could seep into the interior of the Euro-2100TE and cause component failure.
- Clean the cash register with a dry, soft cloth. Never use cleaning agents such as petrol or solvents. Using such chemicals can result in discolouration or deterioration of covering.
- Avoid spilling of any liquids on the cash register as it may cause damage. The keyboard should be protected extra carefully.
- Connect the cash register with the supplied adapter into a standard network plug (230V ± 10%). Other electrical equipment connected in the same network circuit may cause improper functioning of the cash register. In an environment with strong interference use the special anti-interference equipments recommended by the manufacturer of the cash register.  
Warning: adapter is only for interior use!
- If the cash register malfunctions, contact your authorised dealer for service. Do not try to repair the register yourself. Do not open the cash register!
- Unplug the AC/DC adapter from its electrical outlet if the device is to be fully disconnected.
- If the red streak appears at the end of the paper ribbon, exchange this ribbon as soon as possible. If the ribbon is exchanged too late, it can damage the printer, or decrease its lifetime.
- Use the paper ribbon, whose end is not glued. If such paper ribbon is used and not exchanged early enough, the printer could be damaged or its lifetime could be shortened. In this case, the damaged printer warranty is not valid.
- Use only high-quality thermal paper ribbons. Improper ribbons may damage the printer or shorten its lifetime. When using suitable ribbons and by properly maintaining the printer, the average lifetime is up to 25 million printed lines!
- Journal paper storage recommendations: Do not expose thermal paper to the sun light. Store at a temperature not higher than 40 °C. Avoid contact with PVC, mollificators, organic solvents or glue. It is important to use only paper ribbons, where manufacturer warrants all needed characteristics. In case of storage recommendations break or using low-class paper ribbons, Elcom company cannot guarantee printing quality and paper ribbons storage.
- Use only the supplied AC/DC adapter or a adapter recommended by an authorised dealer for electrical connection. Using other adapter types may result in damage to the adapter or the cash register.

- Use only the program recommended by your authorised dealer and use only the original interconnecting cable for cash register communication with a computer. For bar code scanners, use only the connection recommended in these instructions.
- If the cash register is used in different ways than those described in these instructions, the dealer cannot be responsible for incorrect data or damage that may result.
- Only equipment which meets the European Union standards (CE) can be connected to the Euro-2100TE. In other cases, the Elcom company cannot guarantee the adherence to standards of whole system. About possibilities of connection with different equipments ask the Elcom company or your authorised dealer of Euro-2100TE for more information.
-  The symbol on the product or on its packaging indicates that this product shall not be treated as household waste. Instead it shall be handed over to the applicable take-back scheme for the recycling of electrical and electronic equipment. By ensuring this product is disposed of correctly, you will help prevent potential negative consequences for the environment and human health.
-  Lead-free technology.
- The latest published versions of manuals are available on the site [www.elcom.eu](http://www.elcom.eu).

## **BASIC DEFINITIONS**

### **Logo**

The heading on each printed receipt is introductory information prior to the description of the purchased goods. It is mainly used to identify the cash register owner (company name, tax information, company identification, etc.).

**Figure 1.1 Receipt logo**



### **Department**

Departments (DPTs) are used to denote groups of goods having some common features (dairy products, foodstuffs, fruit, etc.). A department is characterised by it's name, parameters, and by the preprogrammed selling price, if it is used for direct sale.

### **Tax level**

Tax level is used for the tax assessment of the sale goods. It's characterized by the percent value, name and tax type (VAT, DO).

## Sales units

Sales units are used in connection with the quantity of sold goods (metres, litres, etc.). Each PLU has assigned a specific sales unit in which the quantity of sold goods is indicated. It's possible to program 8 sales units with a maximum of three characters.

## PLU

PLU (*Price Look Up*) is an abbreviation for the denomination of the specific goods (goods item). The PLU code represents the goods name, the sale price, bar-code and flags (assignment to a department, VAT level, PLU type etc.). For example: Fat milks - 0,85 GBP, White yoghurt - 1,20 GBP).

## Connection between departments and PLUs

The example in figure 1.2 clearly illustrates the relation between the departments and the goods items (PLUs). Sixteen PLUs and four goods groups were used here.

Figure 1.2 Connection between PLUs and departments

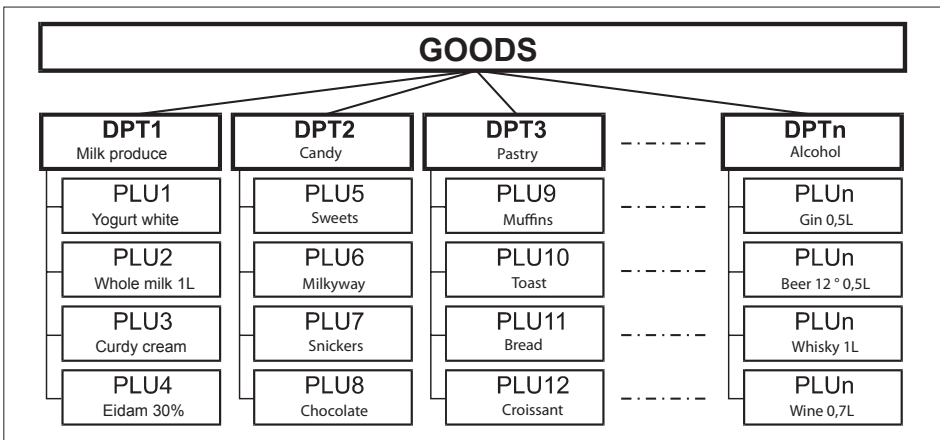

## Report

A report is a sales overview of a particular choice (financial, total, cashiers, PLU etc.)

There are two basic types of reports: "X" and "Z".

"X" reports print the concrete sales values (according to the report chosen) without resetting the data.

"Z" reports print the sales values of the chosen report. After values print out, all values are reset to zero in the cash register memory.

## Bar code

Coding of the numeric description of products into bars corresponds with clearly defined international rules. If a product has an assigned bar-code, it appears on each of these goods. The most frequently used code for product or merchandise denomination in Europe is the 13-digit code according to the EAN norm (EAN-13) and the 8-digit code (EAN-8).

Figure 1.3 EAN bar-codes



### Bar-code scanner

A bar-code scanning device is used to improve speed and accuracy in goods registration.

Figure 1.4 Bar-code scanner

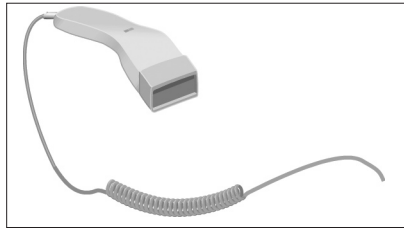

### System flags

System flags are basic settings of the ECR that largely influence correctness of cash register functions (number of decimal places, system of numbers rounding, date, time, etc.).

### Cumulated totals (Grand totals)

Cumulated totals are variables that cumulate the values from all sales. There are usually three known grand totals: GT1, GT2, and GT3. Their meaning is as follows:

- GT1** – gross turnover - this means the cumulated total of all positive values registered in the ECR
- GT2** – net turnover - the net turnover means the difference between gross turnover and negative turnover
- GT3** – negative turnover - this means the cumulated total of all negative values (refunds, discounts...) registered in the ECR.

### Concepts defining the launch of the euro currency, or payment in a foreign currency

#### Conversion rate

The conversion rate is the total irrevocable fixed exchange rate between the euro and the national currency which the Council of the Europe Union accepts according to special provisions and according to which the currency will be replaced by the euro from the day the euro is introduced into the country.

#### Dual display

The dual display of prices, payments and other values is the depiction and introduction of prices simultaneously in the national currency as well as in the euro currency exclusively according to the fixed exchange rate and other regulations for the changeover from national currency to the euro. Thus, prior to the day the euro is launched, monetary sums presented in the national currency are at the same time introduced, for informational purposes, in euros, and from the day the euro is launched, including the day of its launch, sums presented in euros are also, For informational purposes, shown in the national currency.

## Dual cash circulation

The period of dual cash circulation is designated as a temporary period of cash circulation which begins on the day the euro is introduced and during which, by law, all cash payments may be made in any valid euro banknotes and coins, including commemorative euro coins which were issued by the European Central Bank, the National Bank, elsewhere in the eurozone or in participating third-party states, and at the same time valid national banknotes and coins, including commemorative national coins which were issued by the National Bank and which were valid on the day the euro was introduced.

## Primary currency

The currency in which all important financial calculations are made and which for the authorised period of the changeover to the euro currency is valid by law in a particular country.

## Foreign (secondary) currency

An optional other currency serving for the making of payments and withdrawals concurrently with the primary currency. The cash register allows the recording of withdrawals and payments for one foreign currency. The foreign currency can be the euro currency or another such as, for example, the American dollar. During the phase of dual circulation of the euro currency and the national currency, however, the foreign currency must be the national currency.

## Dual currencies

The currency serving for informational calculation and display of monetary sums. It is generally not possible to make payments, deposits or withdrawals in this currency. This does not apply if the dual currency is identical to the foreign currency (dual cash circulation).

## Mix&Match discount group's specification

The cash register is equipped with a special discount system called Mix&Match. The discount will be applied to the accounting PLU that is set to the active the Mix&Match discount group and when the value of the discount trigger is passed. A total of 30 different Mix&Match groups are available.

The programming of the discount system is performed in P mode by pressing the **SKIFT** **MODE** (DUPLICATE) key. The following parameters can be programmed for each discount group:

Name of a group (printed on the receipt when the discount is applied)

Quantity to apply (quantity of goods to 3 decimal places which will trigger the discount. The discount is disabled by setting this parameter to zero)

Discount value (The discount is disabled by setting this parameter to zero)

Each PLU can be assigned to a Mix&Match group. By default, no PLU is assigned to any discount group. This has to be done manually for each PLU either from the computer via the Euro2A communication program or manually via the PLU flag. Before assignation, the discount group has to be set.

When programming from the PC, the Mix&Match group can be programmed with the help of the Euro2A software and the PLU's can also be assigned to a discount group with the help of the mentioned PC software. The Mix&Match discount group must be set in the Mix&Match setting dialog. The assigning of a PLU to a discount group is done in the PLU list by first selecting the PLU and then setting the number of the Mix&Match discount system. However, the selected Mix&Match discount has to be set and be active.

***CASH REGISTER  
CHARACTERISTICS***

## **PARTS OF THE CASH REGISTER, BASIC PARAMETERS**

The cash register Euro-2100TE belongs to the middle segment of ECRs. It's designed for more frequented establishments, convenience stores, bars, coffee-bars and luxury stores. The long term experience with development and manufacture of electronic cash register and deployment of the most recent technologies enabled us to produce this mature electronic cash register. The cash register Euro-2100TE belongs to the top of the class with regard to its technical parameters and friendliness of use. For improving speed and accuracy in goods registration you can use programmable keyboard. The Euro-2100TE also optionally includes an internal battery (which allows up to eight hours of cordless operation). Built-in UV Led module became hit for merchants. For communication with PC you can use USB or serial interface. Simply you can create cash registers network, or connect many different peripheral devices - such as a cash drawer, personal computer, bar code scanner, payment terminal, external programmable keyboard and two electronic scales in the same time. The Euro-2100TE already now fully supports payments in Euro currency.

The characteristic feature of the Euro-2100TE is the capability to store the journal tape contents electronically and printing it later or transferring to PC and storing it. The memory capacity for the storage of electronic journal is at least 500 receipts, with eight items each. According to the electronic journal flags, the stored journal can be printed along with daily report or separately, or it can be transferred to a PC and there consequently processed/archived with accordance to local fiscal law regulations.

The data stored in the electronic cash register memory can be arranged in two formats (see next chapter about electronic cash register programming). First format contains the sale data themselves, journal tape. Second format is designed for PC communication/processing (invoices, stock inventories...).

The electronic cash register function memory manager is used to set the PLU number and to separate the memory for the journal and for the PLU's in order to achieve the best possible memory allocation that will fit the needs of the user. If the user sets less memory than is preset by default for the PLU, the freed memory will be used for the journal. Changing the number of a PLU is possible during initialization of the electronic cash register (programming of electronic cash register) or with the help of job 45682 in the P mode.

Other noticeable features are non-financial PLU movements. The special key sequences enable non-financial PLU movements (i. e. receiving/handing out stock, inventory and stock order) that allows you to issue special documents like delivery lists or others. This feature allows the cashiers to make changes to electronic cash register's article stocks amounts, but the sale is not included in the electronic cash register financial data. Depending on the electronic cash register settings, the electronic cash register can perform a check that the given customer exists in the electronic cash register descriptive PLUs database prior actual handing out from stock. This handing out from stock can then be conveniently used when transferred into PC (issue an invoice, process stock, etc.).

Customer number is used for tracking of receipts in text and binary journal, usually by using of specialised PC software. After transferring the sale data to PC, it is possible to process the sale data further to get a more detailed overview of sales.

The Euro-2100TE can be powered from:

- 230V ( $\pm 10\%$ ) power mains via power adapter
- built-in accumulator (optional)

The packaging contains the electronic cash register itself, power adapter, accumulator and CD with PC communication software suite. Optional accessories are: cash drawer, payment terminal, electronic scales, external PC keyboard, external programmable keyboard, bar code scanner, UV LED module for checking of banknotes, module for Ethernet communication.

The electronic cash register construction is designed to fit demanding criteria of ideal ergonomic workplace and offers several ways of positioning the electronic cash register on the counter or cash drawer using two-sided adhesive tape. electronic cash register design with extensible legs allows for easy access to all communication ports and does not hinder positioning of the electronic cash register.



The unique built-in touch sensitive keyboard, which is manufactured using the up-to-date matrix technology, is the default electronic cash register feature. The unique transparent touch panel allows easy replacement of key labels and also complements the elegant design of the Euro-2100TE cash register. The keyboard is composed of 36 individually programmable keys. The Shift key is used to programme two levels of data for each key thus extending the key availability to 72 states. Each key can be programmed to produce any sequence of standard keyboard strokes, such as direct registration of individual items, departments, discounts and surcharges, etc. Calculator is a new feature that will allow you to perform arithmetic operations (addition, subtraction, multiplication, and division) without registering or while receipt is opened.

The Euro-2100TE provides several management functions and reports. It supports completely national or native language and its special characters. Both the programming and the reports are in native languages.

**Figure 2.1 – Basic features of the Euro-2100TE**



**Figure 2.2 The Euro-2100TE parameters**

Destination	more frequented establishments, convenience stores, bars, coffee-bars and luxury stores
PLUs	1100 to 16000
DPTs	30
MIX&MATCH	30 groups
Cashiers	6
Cashiers login	password, access rights
Tax levels	4
Printer	thermal, LT1320
Printing speed	max. 17 lines/s
Paper ribbon	thermo, 1 x 57 mm

## Cash register characteristics

Number of PLU name characters	20
Number of logo line characters	24 / 12 (normal / bold)
Top text logo	max 9 lines (last line organization ID)
Bottom text logo	max 2 lines
Top graphic logo	360 x 120 pixels
Bottom graphic logo	360 x 240 pixels
Capital characters	yes
Bold characters	
Special characters	
Keyboard description	native
Programming language	
Receipts language	
Reports language	
Reports	DPT, PLU, financial, daily and monthly hourly, cashiers, daily, periodical, interval, el. journal, data for PC, stock
Operation conditions	temperature 0-45 °C, humidity 80 % and lower by teperature 30 °C
Cashier display	alphanumeric 20+10+6 characters
Customer display	alphanumeric 20+10+6 characters
Clean Cash interface	RS-232
PC interface	USB, RS-232, RS-485
Scales and scanner	RS-232
External keyboard	PS/2, PC keyboard, EK-3000, EK-5000
Cash drawer	solenoid 24 V
Dimensions [mm]	350 x 320 x 210 mm
Weight	2,4 kg
Power	adapter 230 V AC / 24 V DC, 1.5 A
Accumulator	2× NiMH 7,2 V / 1600 mAh (not included)
Power saving mode	yes
Power consumption	max. 36W
Optional accessories	cash drawer, digital scales, scanner, payment terminal, external keyboard, external PC keyboard, RS-232/Ethernet interface, internal battery.

## Peripheral devices

The optional external devices are plugged into connectors that are shown in figure 2.4.

Recommendation: Ask your cash register dealer on the possibilities for connecting optional external devices to the electronic cash register.

Figure 2.3 – External equipments for the Euro-2100TE

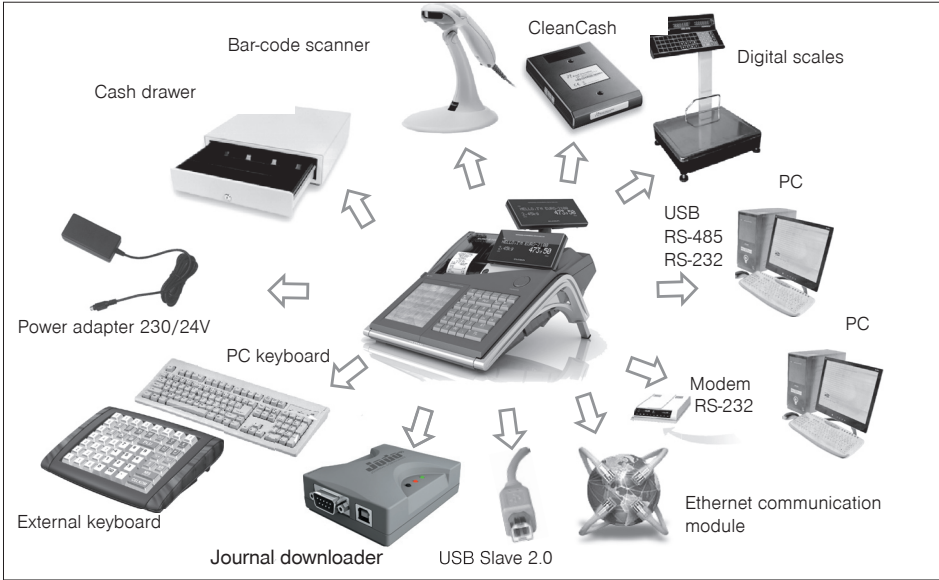
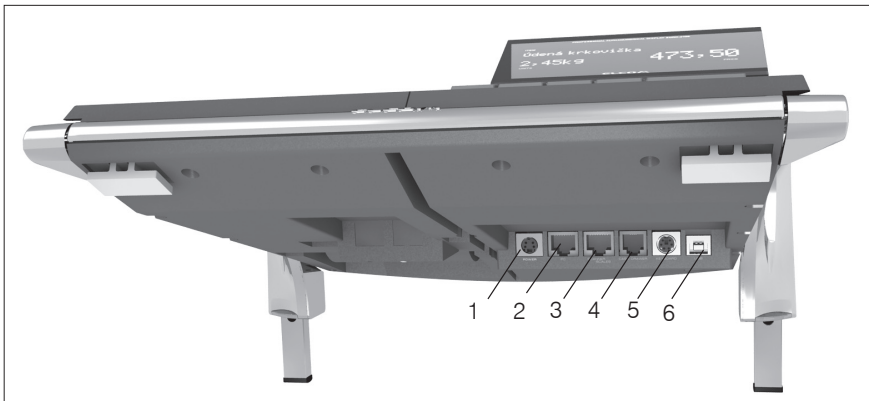

Figure 2.4 – Rear connectors of the Euro-2100TE cash register



- POWER (1): Power supply adapter port
- PC (2): CleanCash, PC, electronic scales port, External journal downloader
- SCAN./SCALE (3): CleanCash, electronic scales, bar-code reader port
- DRAW. (4): Cash drawer port
- KEYB. (5): External keyboard, keyboard scanner port
- USB (6): PC USB port

## THE EURO-2100TE KEYBOARD

Keyboard of the cash register Euro-2100TE is divided into three basic key groups – department keys, numeric keys and function keys. The keyboard layout is programmable and can be changed with the help of the Euro2A program. By default it contains numeric pad and functional key's. If there are two functions on a single key, then you select the bottom function by simply pressing the key. When you wish to use the top function on a key, the first press **SHIFT** key, then press the desired button. Shift key works in the sticky key mode. The keyboard is very comfortable and is ready for daytime work. The keys are marked by large simple icons for fast orientation.

### Warning:

The keyboard is sensitive to dusty environments, humidity and dirt. Use dry clean cloth to clean the plastic covers of the electronic cash register. Never use cleaning agents as technical gasoline or solvents. Such chemicals can damage the plastic cover or cause discolouration. If you need to clean heavily soiled plastic parts, we recommend 3M cleaning spray.

Figure 2.5 – The Euro-2100TE keyboards

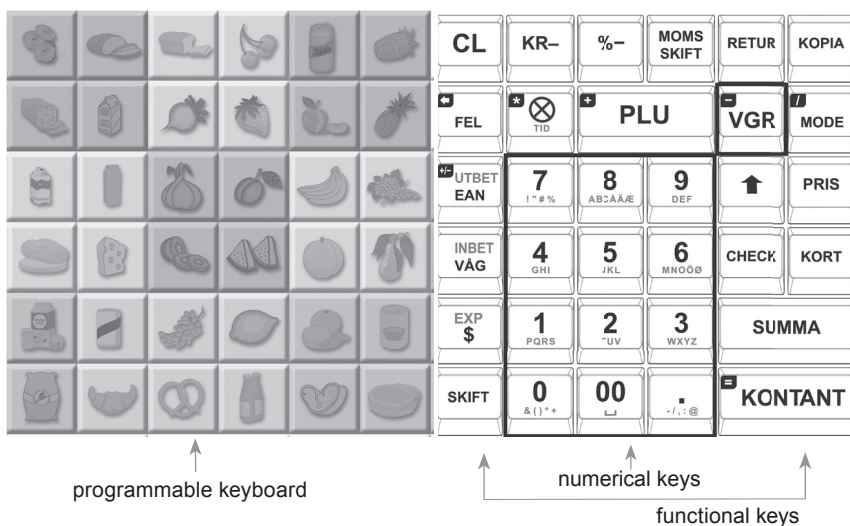

## NAMES AND FUNCTIONS OF ELECTRONIC CASH REGISTER KEYS

- 0** ... **9** Numerical keys are used for entering numerical values and in the programming mode “P” are used for entering text.
- VGR** Department keys are used for registration of department sales. Also used for reports of department sales in “X” mode and for department programming in “P” mode.
- VGR 6** ... **VGR 10** DPT1 and DPT10 are not directly on the keyboard, but they can be used and programmed with the Euro2A software. This keys are used for direct access to sell goods.
- CL** The Clear button is used to clear an amount that has been entered incorrectly from the numeric keyboard. This button also cancels an incorrectly entered function and the sound signalling ERROR/ALARM. It cancels wrong letters when writing texts.
- FEL** The Void button is used to correct an item that has already been registered. It is also used for function texts programming in “P” mode.

RETUR	The Refund button enables you to pay back money, e. g. for damaged goods, as an independent transaction with a separate receipt. It is also used for VAT levels programming in "P" mode.
UTBET KAN	In the P mode it is used to program the bottom text logo, and in the menu listing it is used to switch to the next item. This key allows you to enter the bar code directly from the keyboard in "R" and "T" mode. In "P" mode, pressing this button allows you to print the concrete programmed values.
INBET VAG	In the menu listing it is used to switch to the previous item. The Scales button is used to register the weight of goods from the electronic scales. It is also used for PLU stock programming in "P" mode. In "X" mode you can print out el. journal by pressing this key.
SKIFT UTBET KAN	The PO (Paid out) button is used to register the paid out cash or checks from the cash register as a non-business transaction. See paid-out function. In the void mode ("R" or "T") this button is used for page up or jump through 5 items back. It evokes a monthly (periodical) report in "X" or "Z" mode. In "Z" mode you have to print out a daily report first. It is also used for logo programming in "P" mode.
SKIFT INBET VAG	The RA (Received on account) button is used to register the received payments if no business transaction has been executed. It records, for example, the insertion of daily opening cash into the drawer. In the void mode ("R" or "T") this button is used for page down or jump forward through 5 items. It is also used for system flags programming in "P" mode.
EXP \$	The Drawer button is used to print the customer number or other reference numbers on the receipt. It is also used to open the drawer with no sale. In the void mode ("R" or "T") this button is used as arrow down or jump to next item. In "X" mode you can print out PC sale data by pressing this key. In P mode this key is used for programming of foreign currency.
SKIFT EXP \$	The Password button is used in "R" mode to identify the cashier by password and to permit the cashier to log in. Through this method, the proper cashier claims responsibility for the transactions. The name of the logged-in cashier, is printed on each receipt header. The transactions are recorded in the cashier's account and are displayed in the cashier's report. In the void mode ("R" or "T") this button is used as arrow up or jump to the previous item. It is also used to evoke the cashier report in "X" mode and for the cashier programming in "P" mode.
↑	The Paper feed button feed the receipt ribbon without printing. The receipt ribbon is fed in 1,5 cm by pressing this button.
⊗	The Multiply button is utilized for multiplication if two or more pieces of the same item are being sold. It is used for displaying the time in the registration mode.
PRIS	The Price button enables manual entry of an item price rather than the preprogrammed PLU or DPT price. It is also used for fast PLU price programming in "P" mode.
MOMS SKIFT	This key is used at accounting to switch to a second price and tax level.
PLU	The PLU button (price look-up) enables to call out the programmed data about an item, price, name, department, VAT, etc. See PLU transactions. It evokes a PLU report in "X" or "Z" mode. It is also used for PLU programming in "P" mode.
MODE	The Mode button is used for switching into the individual modes of the cash register and also to enter in menu mode.
KOPIA	After finishing a transaction in R mode, print out the same receipt again by pressing Duplicate button. The receipt is denoted KOPIA.
KORT	The Credit button is used to finalize the sale in case of credit card payment. In "P" mode, when programming PLUs.
CHECK	The Check button is used to finalize the transaction in case of check payment. It also evokes a financial report in "X" mode and is used for the programmed data printing in "P" mode.
%~	After entering percent of discount, this key is used to set percentage discount. The discount value has to be in the discount limit range.
KR~	After entering value of discount, this key is used to set value discount. The discount value has to be in the discount limit range.
SUMMA	The Subtotal button displays and prints the actual subtotal value according to the setting of the fourth system flag. Also switch between submodes of non-financial PLU movements in "R" and "T" modes. In the listing menu this is used for confirmation.



The Total / Cash button is used to finalize the sale in case of cash payment. It also evokes a daily report in "X" or "Z" mode. In the menu this is used to confirm the chosen item (certified version)



The function in an upper part of a key is chosen by holding the Shift button and then pressing the key with two functions.

## **ELECTRONIC CASH REGISTER DISPLAYS DESCRIPTION**

### **Cashier display description**

The cashier display of Euro-2100TE is a colour alphanumeric LCD display with 36 characters. The high quality of display, its contrast and brightness are result of black mask technology. This type of display complements the uniqueness of the Euro-2100TE cash register. For improved readability, the display is divided into three groups: the article name (first row, twenty characters), amount and type of article (second row, six characters) and finally the article price (second row, ten characters). The visibility of displayed data is also enhanced by the special green-white colour combination for characters and by using two character sizes.

The displays fully support national characters (if needed) and allow also other characters (as numerals and special characters). It's easy and comprehensive to read from this type of display.

The cashier display has back-light installed by default.

Figure 2.6 – Alphanumeric LCD display

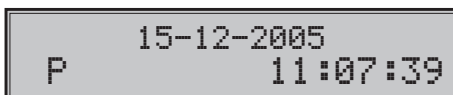



### **Customer display description**

The Euro-2100TE customer display is an alphanumeric LCD display (the display type is identical with the cashier display).

The customer display has back-light installed by default.

## **MODES SWITCHING**

By combining the numerical keys from  to  and the  (MODE) button it is possible to set the mode of the cash register. Such switching thus enables the operator to work in different cash register modes (registration, programming, reports, etc.).

"R" - Registration mode. This mode is used for all registrations and transactions. After switching into this mode, the current date in the first line and current time in the second line appears on the display until you begin registration.

Switching into the "R" mode:  

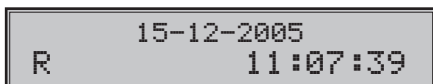

"X" - The "X" mode is used to print sales reports. The printing of "X" reports does not reset the current sales data.

Switching into the "X" mode: 

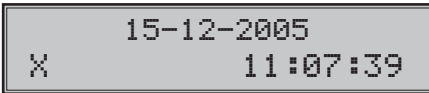

"Z" - The "Z" mode is used to print various reports. The printing of "Z" reports resets the cash register sales data.

Switching into the "Z" mode: 

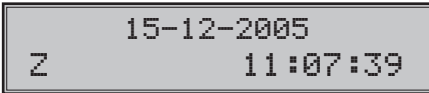

"P" - The "P" program mode is used to program all values and functions of the cash register.

Switching into the "P" mode: 

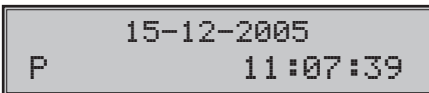

"T" - The training mode provides all functions of the "R" mode, but in this mode, the transactions are not included in the daily or monthly (periodical) reports. The receipts printed in this mode are marked by the text "Invalid document".

Switching into the "T" mode: 

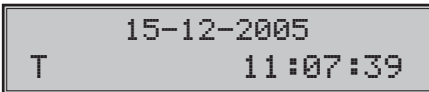

"STANDBY" When the cash register is not operated for certain time limit (see chap. System flags programming) and it is supplied from internal power supply, it will switch into the "Standby" mode. A cash register in the "Standby" mode has a low consumption of energy. The notification "Standby" appears on the display.



Exit the "STANDBY" mode by pressing the  (MODE) button. In case the cash-register is supplied from external power supply then stand by mode is not called.

## **PAPER RIBBONS INSTALATION**

The Euro-2100TE cash register uses thermal paper ribbons 57 mm wide. The paper ribbon is designed for the printing of customer receipts and for the printing of the control ribbon (journal) also.

**Figure 2.7 - Paper ribbons installation procedure for Euro-2100TE**

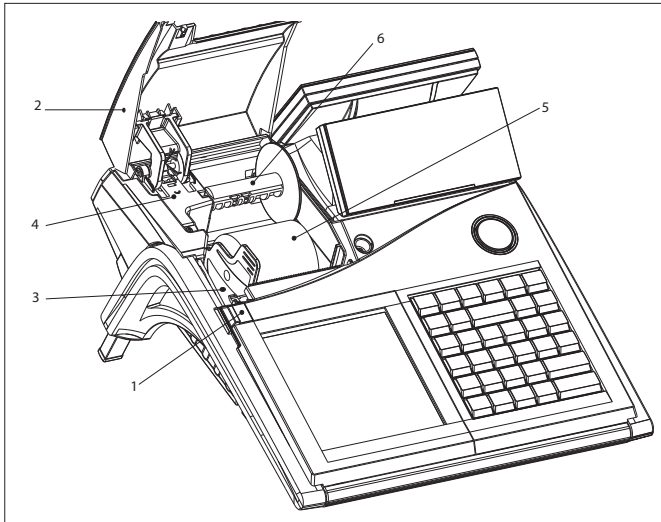

We recommend to use only rolls of good quality paper with the maximum diameter of 55 mm. To ensure proper cash register operation, make sure that the printing saturation is correct. If any problems occur, contact your local authorized dealer of the Euro-2100TE.

### **Paper ribbons installation procedure for Euro-2100TE (numbers according to Figure 2.7):**

Press the control button (1) to flip the tape cover (2) open. Take out the paper tape separator (3) along with empty paper reel, remove it and install new paper tape reel (5). Insert the separator with installed tape into the bottom cover (4). The tape's end must not contain dirt or glue residue. Insert the tape (5) into the printer, the printer will load the tape automatically into its mechanism. Close the tape cover (2). Finally, press button to feed necessary amount of tape or cut off any surplus tape.

Recommendation: If the tape wrinkles or jams during loading, use the printer head lever to lift the printing head up and take out the jammed tape. Fix the tape, lower the printing head down and try to re-load the tape again.

## **Usage and storage of thermal paper**

The Euro-2100TE printer prints on paper 57 mm wide.

Journal paper storage recommendations:

- do not expose thermal paper to direct light,
- air humidity max. 40 to 60 %,
- store at temperature not higher than 40°C, the best is room temperature from 18 to 25 °C,
- avoid contact of thermal paper with PVC, mollificators, organic solvents or glue.

It is necessary to use good quality paper rolls.



If usage or storage recommendations are not followed, Elcom s. r. o. does not guarantee high quality printing or preservation of printed data.

Change the paper roll immediately, if the red colour stripe marking the paper end appears at the paper ribbon. Late change of the paper roll can cause the damage of the printer or it can shorten the printer's lifetime.

## **CALCULATOR FEATURE DESCRIPTION**

### **Implemented functionality**

The built-in calculator is able to perform these operations on real numbers:

- addition
- subtraction
- multiplication
- dividing

Maximum precision is 13 valid numbers.

The maximum range overflow ( $\pm 1,79 \times 10308$ ) error is not handled.

### **Keyboard operation**

You can toggle the calculator functionality of the electronic cash register using the [CALC] key (a special round button on the top edge of the keyboard).

Individual operations are realised using following keys:

- PLU – addition
- DPT – subtraction
- MULT – multiplication
- MODE – dividing
- TOTAL – displays result
- CLEAR – initialises the calculator (electronic cash register enters the state before calculator has been used)

Entering and editing numbers:

 – enter number

 – enter decimal separator

 – invert sign (positive sign is not displayed)

 – deletes the last entered number

It's possible to enter up to 14 digit signed number, including decimal separator. Single sign (i. e. sign entered without a number) is ignored. The calculator retains the last performed operation and it could be repeated using the TOTAL key.

### **Calculator display**

After the electronic cash register is switched into calculator mode, the bottom display row shows "Calculator".

Entered numbers are shown in the top display row; result is displayed similarly.

The current operation sign (+, -, \*, /) is displayed in front of the "Calculator" text in the bottom row.

**Examples:**

Display shows after pressing 16 + 45:



Display shows after pressing TOTAL:



Display shows after pressing TOTAL:

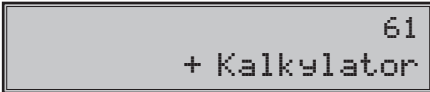

While the electronic cash register is in the calculator mode, the customer display remains empty.

# ***PROGRAMMING MANUAL***

## INITIALIZATION

If the electronic cash register is being used for the first time, it's suggested to first initialize the electronic cash register. At initialization, all information will be erased from the electronic cash register and the electronic cash register will have factory default settings and data. Only the cumulative sum – GT, the order number of the daily and monthly reports and the value of the first system flag – will be unaffected. Initialization can be done only after a daily or monthly (periodic) report in Z mode and the saving of the electronic journal.

Initialization procedure:

- 1) 1) Start the electronic cash register by pressing , then switch to P mode.

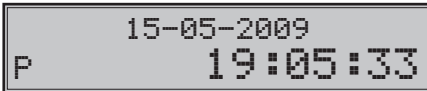



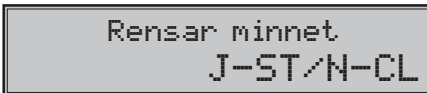

15-05-2009  
P 19:05:33

- 2) Press key . The words „Memory clearing“ will appear on the display and in the bottom row will be the options for continuing with data erasing ( Y-ST ) or cancellation of initialization ( N-CL ).





Rensar minnet  
J-ST/N-CL

- 3) To confirm initialization, press  (SUBTOTAL). To cancel, press .
- 4) After confirmation, on display will be the actual set PLU range and the interval in which the user can choose the PLU limit number. By entering numbers from  to  the user can set the number of PLU depending on the hardware memory extension:



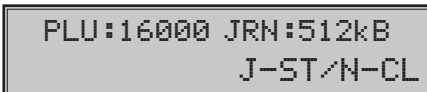

PLU antal: 16000  
Intrvl 1100-16000

- 5) To confirm the setting for the number of PLUs, press  (SUBTOTAL), or cancel the initialization with key  (TOTAL).
- 6) After entering the number of PLUs, rounded up to the hundred, the memory available for the journal will be displayed.



PLU:16000 JRN:512kB  
J-ST/N-CL

- 7) If the settings are correct, confirm initialization with the set number of PLUs and the memory left for the journal by pressing the key  (SUBTOTAL) to continue or the key  to go back to the number of PLUs setting.
- 8) After confirmation of initialization, the message “Memory clearing“ will appear on the display, and the same message will be printed on a receipt, after which the electronic cash register will start initialization.
- 9) Enter the date in the format (DDMMRR) and the time as (HHMM).

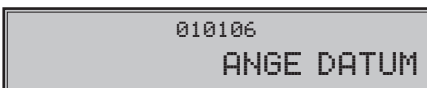

010106  
ANGE DATUM

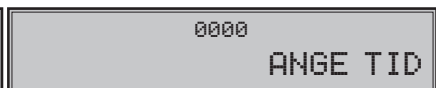

0000  
ANGE TID

- 10) After entering of the date and time, the electronic cash register will print a message summarizing memory allocation Memory clearing.

```

Minnet rensas
Ändr. av minnes.
PLU antal          7000
JOURNAL storlek    512kB
Minnet rensat

```

## RECOMMENDED PROCEDURE FOR THE EURO-2100TE PROGRAMMING

### The menu in Programming mode

This function allows the user to list the electronic cash register settings on the display and to set parameters like PLU, system flags and descriptive text. This menu can be accessed after switching into P mode, by pressing the **MODE** (MODE) key. The setting parameter will appear in the top row, and the order number of the set item with the description "Select - TL" will appear in the second row.

```

          PLU LAGER
1 SELECT - KON

```

Shifting between items can be done with the **SUMMA** (SUBTOTAL), **INBET VAG** (SCALE) or **SKIFT INBET VAG** (RA) keys to switch to next item and with the **UTBET EAN** (EAN), **SKIFT UTBET EAN** (PO) key to go back to the previous item in the list. To start the setting dialog, press the **KONTANT** (TOTAL) key or to cancel a listing, press **CL** (CLEAR).

After entering the programming dialog, the electronic cash register will request the input of the specific item number to be programmed (number of PLU, DPT, system flag, etc.). The entered number has to be confirmed with the **SUMMA** (SUBTOTAL) key or programming cancelled with the **KONTANT** (TOTAL) key. Incorrect values can be deleted with the **CL** (CLEAR) key.

Please note: If when selecting a specific item no number is entered, programming will start from the first item. To enter an item number, use the numeric pad **0** 0 - **9** 9 or use **0** 0, **00** 00 and **.** . to enter a 10th, 11th, and 12th, number.

### List with items in the P mode menu

#### Euro 2100 TE

- |                       |                        |
|-----------------------|------------------------|
| 1. PLU LAGER          | 9. LOGORADER SIDFOT    |
| 2. PLU                | 10. FUNKTIONERS TEXTER |
| 3. PLU PRIS           | 11. MOMS               |
| 4. VGR                | 12. Fo:RS.ENHET        |
| 5. SYSTEM FLAGGA      | 13. KASSo:R            |
| 6. EXT FLAGGA         | 14. VALUTA             |
| 7. MIX&MATCH          | 15. VERSION            |
| 8. LOGORADER SIDHUVUD |                        |

The recommended procedure for electronic cash register programming advises a user to program the electronic cash register in the following order: 1) system flags, 2) tax levels, 3) extended flags, 4) receipt logo, 5) cashiers, 6) function texts, 7) departments, 8) sale units, and finally 9) article items (PLUs), and 10) Mix&Match.

The Version Info is showing the actual firmware version that is installed on the electronic cash register and the manufacturer of the electronic cash register.

## SYSTEM FLAGS PROGRAMMING

Prior to programming of the electronic cash register, it is recommended that this sub chapter is carefully studied and clearly understood.



**Note:**

If a key is used for two functions, choose the function in a lower part of a key by pressing the key. To choose the function in the upper part of a key, press once the  (SHIFT) key and press the particular key.



### Initial programming of system flags

The system flags represent settings that have primary influence on the proper performance of electronic cash register (number of decimal places, rounding, date, time, etc.).



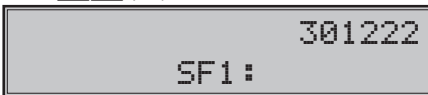

System flags programming procedure:

- 1) Switch the cash register into the “P” mode by pressing . On the display appears „P” (left bottom on the display). Only a cashier authorised for the programming mode can set the electronic cash register into the “P” mode.
- 2) Press  (RA) buttons.





- 3) After entering flag values, store them by pressing the  (SUBTOTAL) button. The programming of the next flag follows. Continue until you have programmed all necessary flags.
- 4) Finish flags programming by pressing the  (TOTAL) button.

### System flags correction

- 1) To change the settings of any system flags, switch the cash register into the “P” mode by pressing .
- 2) Enter the flag number to be edited and press the  (RA) buttons.
- 3) Enter desired flag value and press the  (SUBTOTAL) button.
- 4) Print the new programmed settings by pressing the  (CHECK) button.
- 5) Finish the programming by pressing the  (TOTAL) button.

### System flags values print out

In the programming mode, select the flags programming by pressing the  (RA) buttons. Press the  (CHECK) button to print the flags values. It is possible to print the value of currently programmed flag by pressing the  (EAN) button.

### Flag 1 – Number of decimal places, method of rounding, TAX system

Figure 3.1 First system flag values

Digit	Default setting	Meaning	Valid values
1	3	System of rounding	0 – up from 5, 1 – always up, 2 – always down, 3 – special rounding
2	0	Tax system	0 – VAT 1 – TAX
3	1	Number. of decimal places to which total price should be rounded	0 – 2

4	2	No. of decimal places to which VAT should be rounded	0 - 3
5	2	No. of decimal places to which price should be rounded	
6	2	No. of decimal places to which price, VAT should be displayed	

*Note:*

*Value of the first system flag can be changed only if grand totals are zero.*

## Flag 2 - TAX printing, number of logo lines, blank lines

**Figure 3.2 Second system flag values**

Digit	Default setting	Meaning	Valid values
1	0	TAX values printing	0 - Net and gross tax value are not printed 1 - Net and gross tax value are printed
2	0	Date format	0 - dd-mm-yyyy, 1 - mm-dd-yyyy
3	3	Number. of decimal places of quantity values	0 - 3
4	3	Number of blank lines between receipts	0 - 6
5	9	Number of logo lines	0 - 9
6	0	Split pricing / successive multiplication entries	0 - split pricing, 1 - successive multiplication
7	0	Print of unit amount	0 - not printed 1 - printed

## Flag 3 - Receipt consecutive number, cash register number

**Figure 3.3 Third system flag values**

Digit	Default setting	Meaning	Valid values
1	01	Cash register number	(01 - 99)

## Flag 4 - Required operations

**Figure 3.4 Fourth system flag values**

Digit	Default setting	Meaning	Valid values
1	1	Subtotal amount print out after Subtotal key is pressed	0 - no, 1 - yes
2	0	Required Subtotal key pressed before receipt is finished	0 - not required, 1 - required
3	0	Required Credit Card number entering if paid by Credit	0 - not required, 1 - required
4	0	Required customer's payment amount entering	0 - not required, 1 - required

## Flag 5 a) - Communication with PC and payment terminal

Figure 3.5 a) Fifth system flag values

Digit	Default setting	Meaning	Valid values
1	1	PC & CleanCash port number	0 - device is not used 1 - PC(2)
2	1	Programming of communication speed for the PC. Parity: none, DataBits: 8, StopBits: 1	0 - 9 600 Bd 1 - 38 400 Bd
3	0	Data transmission direction in PC-ONLINE mode	0 - function not used
4	0	Payment terminal port number	0 - device is not used
5	1	Communication protocol for payment terminal	0 - device is not used
6	0	External Journal Reader connectivity (Port replication)	0 - device is not used 1 - device is connected

**Note:**

\* If the electronic cash register had connected to the PC port, an Scale, the flag which is setting it will be automatically changed to the replicated port on external journal reader.

\* With USB communication (or with RS458 communication), in order to switch on the communication port, the first number of the 5th system flag has to be set to 1. With USB communication, a USB driver has to be installed on the PC from the support CD; it is also available at [www.elcom.eu](http://www.elcom.eu).

## Flag 5 b) - Scanner and scales configuration

Figure 3.5 b) Fifth system flag values

Digit	Default setting	Meaning	Valid values
1	2	Scanner & CleanCash port number	0 - device is not used 2 - SCAN./SCALE (3)
2	3	Bar code scanner communication speed	0 - 1 200 Bd 1 - 2 400 Bd 2 - 4 800 Bd 3 - 9 600Bd 4 - 19 200Bd
3	0	Terminal code for the bar code scanner	0 - terminal CR and LF 1 - terminal CR 2 - terminal LF
4	2	1st scale port number	0 - device is not used 1 - PC(2) 2 - SCAN./SCALE (3)
5	0	Communication protocol for 1st electronic scale	0 - CAS Morcan, MARTES T 1 - Euro scales, MARTES M 2 - Macca K 3 - Dibal 4 - Motex R 6 - Mettler Toledo 7 - ACOM 8 - CAS Morcan TP2
6	1	2nd scale port number	0 - device is not used 1 - PC(2) 2 - SCAN./SCALE (3)
7	0	Communication protocol for 2nd electronic scale	Same as „Communication protocol for 1st electronic scale



**Note:**

If the electronic cash register had connected to the PC port, any scale, the flag which is setting it will be automatically changed to the replicated port on external journal reader.

At port SCAN / SCALE (3) a scanner and scale can be connected simultaneously with the help of an adapter.

**Flag 5 c) - External RS-485 converter settings****Figure 3.5 c) Fifth system flag values**

Digit	Default setting	Meaning	Valid values
1	0	External RS-485 converter using	0 - no, 1 - yes
2	1	Active level of signal for RS-485 converter control	0, 1
3 - 6	0000	Time in tenths of $\mu\text{s}$ [ $\mu\text{s} \times 10$ ], which electronic cash register has to wait before packet sending	0 - 2 000 i.e. 0 - 20 000 [ $\mu\text{s}$ ]

**Flag 5 d) - Clean cash communication port settings****Figure 3.5 d) Fifth d system flag values**

Digit	Default setting	Meaning	Valid values
1	1	Port for communication with CleanCash	1 - PC(2), 2 - SCAN./SCALE (3)
2	2	Programming communication speed for Clean-Cash	0 - 9600, 1 - 19200, 2 - 38400

**Note:**

The CleanCash communication port parameter can be set to 1 if connected to port PC(2), or 2 if connected to SCAN / SCALE (3). A port shared with the CleanCash connection can be combined with any other device except a scanner.

**Flag 6 - Printing mode settings****Figure 3.6 Sixth system flag values**

Digit	Default setting	Meaning	Valid values
1	0	Printing modes with no external power supply	0 - normal mode
2	0	Printing modes with external power supply	
3	1	Upper graphical logo printing	0 - no, 1 - yes
4	1	Lower graphical logo printing	
5	0	Font size	0 - normal font
6	1	Standby mode	0 - standby inactive, 1 - standby after 1 min., 2 - standby after 5 min., 3 - standby after 10 min., 4 - standby after 15 min.
7	2	Stage of calculator key back-light in Calculator mode	0 - off, 1 - on, 2 - blinking
8	0	Stage of calculator key back-light outside of Calculator mode	0 - off, 1 - on

### Flag 7 - Limit and value of the percent add-on

You can shift from limit to value programming by pressing the **SUMMA** (SUBTOTAL) button. The directional arrow shows if either limit or value, is actually programmed.

Figure 3.7 Seventh system flag values

Digit	Default setting	Meaning	Valid values
1 - 2 Left	00	Limit for the percent add-on entered during sale	00-99
3 - 6 Right	0000	Programmed percent add-on value (to program 10% add-on enter 1 0 0 0)	0000-9999

### Flag 8 - Limit and value of the percent discount

You can shift from limit to value programming by pressing the **SUMMA** (SUBTOTAL) button. The directional arrow shows if either limit or value, is actually programmed.

Figure 3.8 Eighth system flag values

Digit	Default setting	Meaning	Valid values
1 - 2 Left	00	Limit for the percent discount entered during sale	00-99
3 - 6 Right	0000	Programmed percent discount value (to program 15% discount enter 1 5 0 0)	0000-9999

### Flag 9 - Time setting

Figure 3.9 Ninth system flag values

Digit	Default setting	Meaning	Valid values
1 - 2	12	Hours setting	00-23
3 - 4	00	Minutes setting	00-59

### Flag 10 - Date setting

The cash register handles leap years and adjusts the number of days in each month automatically.

Figure 3.10 Tenth system flag values

Digit	Default setting	Meaning	Valid values
1 - 2	01	Day	01-31
3 - 4	01	Month	01-12
5 - 6	01	Year	00-99

## EXTENDED FLAGS PROGRAMMING

The extended flags are data which enable the user to set particular electronic journal functions, bar-codes flags, etc.

Extended flags programming process:

- 1) Enter the programming mode "P" by pressing **4** **MODE**.
- 2) Press the **%-** (PERCENT DISCOUNT) button.
- 3) After entering proper flag values, store them by pressing the **SUMMA** (SUBTOTAL). The programming of the next flag follows. Continue until all necessary flags have been programmed.
- 4) Programmed flag settings may be printed by pressing the **CHECK** (CHECK) button.
- 5) Finish the programming by pressing the **TOTAL** (TOTAL) button.

## First extended flag

If the fifth digit is 0, previous digit values are ignored.

**Figure 3.11 First extended flag values**

Digit	Default setting	Meaning	Valid values
1	0	Not used	
2	0	Not used	
3	1	Store text logos in the electronic journal	0 - no, 1 - yes
4	0	Print and clear electronic journal together with daily report	
5	1	Store sale data in electronic journal	1 - yes
6	0	Automatic saving of electronic journal to the memory card through an external journal reader upon reaching 90% of journal capacity and automatic erasing from electronic cash register.	0 - no, 1 - yes

*Note:*

*In the case of electronic journal downloading to PC is good to set up 4th digit to zero.*

*If the 6th value is set to 1, than upon setting the 4th parameter to 1, the electronic journal will be saved automatically during the daily report and erased afterward.*

## Second extended flag

If the second digit is 0, the value 2 of first digit is ignored

**Figure 3.12 Second extended flag values**

Digit	Default setting	Meaning	Valid values
1	0	Handing out of stock according to delivery note	0 - handing out is disabled, 1 - handing out is possible without customer's checking, 2 - handing out is only possible with customer's checking
2	0	Mandatory entry of customer number at hand out stock	0 - no, 1 - yes
3	1	Update PLU sale data upon handing out from stock (handed amount and total hand out value)	

*Note:*

*To change third digit is possible only after "Z" PLU report.*

## Third extended flag

If the third digit is 0, the value of first two digits are ignored

**Figure 3.13 Third extended flag values**

Digit	Default setting	Meaning	Valid values
1	0	Store tax information in PC data	0 - no, 1 - yes
2	0	Allow clearing of PC data in electronic cash register	
3	0	Store data for PC	

## Fourth extended flag

**Figure 3.14 Fourth extended flag values**

Digit	Default setting	Meaning	Valid values
1	0	Allowance to refund	0 – all cashiers are allowed to refund, 1-6 – specifies which cashier is allowed to refund
2	0	Bar-code printing	0 – without bar-code, 1 – print bar-code with final price at the end of receipt, 2 – print code for every PLU with encoded amount, 3 – print code for every PLU with encoded price, 4 – print programmed bar-code for every PLU
3	1	Number of empty rows after the bar-code print out	0-9
4	1	Print numerals in bar-code	0 – bar-code will not contain numerals, 1 – bar-code will contain numerals
5	2	Number of decimal places for encoding price into the bar-code	0-3
6	5	Maximum number of places for encoding price into the bar-code	1-5

## Fifth extended flag

The prefixes 26, 28 or 29 are recommended for amount encoded bar-codes, prefixes 21, 24 or 27 are recommended for price encoded bar-codes.

**Figure 3.15 Fifth extended flag values**

Digit	Default setting	Meaning	Valid values
1-2	00	Bar-code prefix	00-99
3-6	0001	PLU number for encoding the final price into bar-code	0001-9999

## Sixth extended flag

Figure 3.16 Sixth extended flag values

Digit	Default setting	Meaning	Valid values
1	0	Look-up algorithm for PLUs when read 18-digits long bar-code	0 – look-up using the entire bar-code, 1 – as option 0, but if look-up fails, the bar-code is considered as EAN 13+5 and extension is ignored
2	0	Look-up algorithm for PLUs when read 15-digits long bar-code	0 – look-up using the entire bar-code, 1 – as option 0, but if look-up fails, the bar-code is considered as EAN 13+2 and extension is ignored
3	0	Printing format and storing format in the PC journal if electronic cash register reads and successfully looks up the 13+5 bar-code	0 – do not print and store anything, 1 – print and store only bar-code extension, 2 – print and store entire bar-code
4	0	Printing format and storing format in the PC journal if electronic cash register reads and successfully looks up the 13+2 bar-code	
5	0	Printing format if electronic cash register reads and successfully looks up bar-code with other length than 15/18 or if a PLU has been read using the PLU number that has length 15/18 and electronic cash register database contains the same EAN code with given length (i. e. it is not considered an EAN 13+2/13+5 code)	0 – do not print anything, 1 – print entire 18-digit long code programmed for given PLU

## Seventh extended flag

Figure 3.17 Seventh extended flag values

Digit	Default setting	Meaning	Valid values
1	0	Printing of PLU number with sales item	0 - no, 1 - yes
2	1	Printing of time on the receipt	

## Eight extended flag

Figure 3.18 Eight extended flag values

Digit	Default setting	Meaning	Valid values
1	0	Checks and credits charge when total is negative	0 - cash paid, 1 - charge by type of payment

## Printing of the extended flag values

In the programming mode, select extended flags programming by pressing the **SKIFT** **KORT** (DISCOUNT) button. After pressing the **CHECK** (CHECK) button flags values will be printed. It is possible to print the value of the particular flag only by pressing the **UTBET** **EAN** (EAN) button.

## TAX RATES PROGRAMMING

The cash register allows the use of four tax rates plus one rate without tax. Both the tax rate and its name are programmable. Tax can be programmed only after daily, monthly report.

Tax level programming procedure:

- 1) Switch the electronic cash register into the programming mode "P" by pressing **4** **MODE**.
- 2) Press the **RETUR** (REFUND) key. The display shows the number of programmed tax level and its rate.



- 3) Enter the tax rate without decimal point. First two numerals compose integer part of the rate, last two compose decimal part (i. e. for tax rate of 19% it is 1 9 0 0). The tax rate can be changed only after daily and periodical report have been executed in "Z" report mode. If you need to disable a specific tax level, programme its tax rate as 100.00% or higher.
- 4) Press the **SUMMA** (SUBTOTAL) key. Display will show label for programming the tax level name.
- 5) Enter name of TAX level, which will be printed on receipts and reports. Save entered value and move to next VAT setting with key **SUMMA** (Subtotal).
- 6) To exit the tax level programming, press **KONTANT** (Total) key. More details on entering texts are located at the end of this chapter.

## Correction of the tax level values

- 1) Switch the electronic cash register into the "P" mode by pressing **4** **MODE**.
- 2) Enter the number of the tax level you want to edit and press the **FEL** (REFUND) button.
- 3) Re-program the parameters as described in section above.
- 4) You can print the newly programmed tax level values by pressing **CHECK** (CHECK) key.
- 5) Finish the corrections by pressing the **KONTANT** (TOTAL) key.

## Printing of the programmed tax values

To verify the programmed values, print them by pressing the **CHECK** (CHECK) button in the tax programming mode. If working in another programming mode, press the **FEL** (REUND) key and then the **CHECK** (CHECK) key. It is possible to print the rate and name of a particular tax level by pressing the **UTBET EAN** (EAN) button.

## Programming of organization ID

The Organization ID is printed as 9th row in the top text logo. To set it, enter P mode **4** **MODE** and enter code **1** **5** **2** **4** **☒**. After that the electronic cash register will request to enter the organization ID with help of the numeric keypad. The organization ID number has the following form: XXXXXX-XXXX.

## PROGRAMMING OF TOP AND BOTTOM TEXT LOGO

The electronic cash register allows to print six rows of text and two rows of bottom logo (ex. Roys Food Store) at the end of the receipt.

Logo programming procedure:

- 1) Switch the electronic cash register to the "P" mode by pressing **4** **MODE**.
- 2) Press the key **SKIFT** **UTBET EAN** to program the top text logo or the key **UTBET EAN** (EAN) to program the bottom text logo.

- 3) The text "RaderLogo1" will appear on the first row of the display when programming the top logo and the text "RaderLogo2" upon programming the bottom logo. The second row will show the number of lines to be printed on the receipt. Enter a number ranging 0 to 6 for the top logo or from 0 to 2 for the bottom logo to set number of printed lines. Set value with the key **SUMMA** (SUBTOTAL).
- 4) The notification „1 LOGO RAD“ appears in the second display row and informs you that you are programming the first line of the text logo and the first display row will show the currently programmed text for that row. Enter new data for the current logo line. If you mistype or make a mistake, you can delete previous characters by pressing **CL** (CLEAR) key. Programmed text will be printed out just as typed in, starting from the left.



Note:

If the text includes bold characters, they are represented as a dark triangle.

- 5) Press the **SUMMA** (SUBTOTAL) key. The next line will appear on the display and is ready for editing.
- 6) Press the **KONTANT** (TOTAL) key to finish the programming of receipt logo lines.

## Correction of the text logo lines

- 1) Switch the electronic cash register to the "P" mode by pressing **4 ON** **MODE**.
- 2) Enter the line number you want to correct and press the keys **SKIFT** **UTBET EAN** (PO) for the top logo or **UTBET EAN** (EAN) for the bottom logo.
- 3) Re-programme with corrected value as shown in section above.
- 4) You can print out the entire logo by pressing **CHECK** (CHECK) key; print out the current line by pressing **UTBET EAN** (EAN) key.
- 5) Finish corrections by pressing the **KONTANT** (TOTAL) key.

## Printing the programmed logo lines

Programmed logo lines can be printed in text logo programming mode by pressing the **CHECK** (CHECK) key. Print a particular programmed line by pressing the **UTBET EAN** (EAN) key.

## RECEIPT GRAPHIC LOGO PROGRAMMING

The electronic cash register is preprogrammed with a graphic logo by its producer. You can reprogram this using the communication software (Euro2A, ECR.dll, Com2A.exe, Com32.dll), available at producer's web site ([www.elcom.eu](http://www.elcom.eu)).

Graphical logo parameters:

Top graphic logo	format	bmp, 1 bit (black and white)
	resolution	360x120 pixels
Bottom graphic logo	format	bmp, 1 bit (black and white)
	resolution	360x240 pixels

## CASHIERS PROGRAMMING

The programming of cashiers consists of four steps:

- cashier's name
- cashier's password
- cashier's access rights
- cashier's access to operations

The electronic cash register allows you to program up to six cashiers. This programming allows you to assign a password to each cashier, which will be used by him/her to log into the electronic cash register and use its functions. This password will also identify the cashier working on the electronic cash register. The receipts issued by that cashier are identified by his/her name and all operations are assigned to him/her.

Programming procedure:

- 1) Switch the electronic cash register to the "P" mode by pressing .
- 2) Press the (PASSWORD) key. Display will show the current cashier number and label ("NAME") in the second display row which indicates that you are programming the cashier's name. First display row contains the current cashier's programmed name.
- 3) Enter the name for the current cashier. Cashier name can have up to ten characters. If you mistype or make a mistake while entering text, you can use the (CLEAR) key to delete recent characters. See the end of the chapter for hints on entering texts.

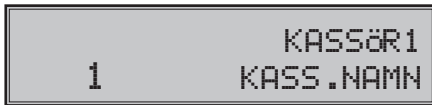

- 4) Finish the cashier name programming by pressing (SUBTOTAL) key. The electronic cash register shows the current cashier number in the second display row, together with the label ("PSWD") that indicates programming of cashier's password. Press (TOTAL) to finish the programming procedure (next steps will not run).

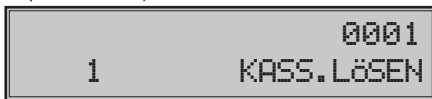

- 5) Enter the cashier's password. The password is composed by the up to four numerals. If you mistype during entering of the password, you can use (CLEAR) key to correct your mistakes.
- 6) Finish the programming of cashier's password by pressing (SUBTOTAL) key. The electronic cash register will then show the current cashier number in the second display row along with label ("ACCES") that indicates programming of cashier's access rights for electronic cash register modes. Press (TOTAL) to finish the entire programming procedure (next steps will not run).

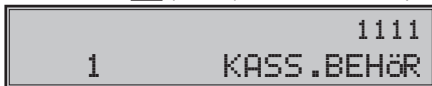

- 7) Program the mode access flags according to the figure 3.19. If you mistype, correct your mistakes using (CLEAR) key. Warning: you cannot deny access to programming mode "P" for the cashier no. 1.

Figure 3.19 Cashier access rights

Digit	Meaning	Valid values
1	Access to the "X" mode	0-no, 1=yes
2	Access to the "Z" mode	
3	Access to the "P" mode	
4	Access to the "T" mode	



- Finish the programming of cashier access rights by pressing **SUMMA** (SUBTOTAL) key. The electronic cash register consequently displays the currently programmed cashier number and label indicating operations are programmed ("OPER") in the second row and the currently valid operation flag for particular cashier in the first row. If you press **KONTANT** (TOTAL), you will finish the cashiers programming.



- Program the operation flags according to the figure 3.20. If you mistype any of the digits, you can correct it by pressing **CL** (CLEAR).

**Figure 3.20 Cashier operations flag**

Digit	Meaning	Valid values
1	"Receive stock" operation	0 – forbidden, 1 – allowed
2	"Hand out stock" operation	
3	"Stock order" operation	
4	"Inventory" operation	

- Press the **SUMMA** (SUBTOTAL) key to continue programming of the remaining cashiers; continue with step 3. If you press **KONTANT** (TOTAL) key, you finish the programming procedure for the cashiers.

### Correction of cashiers values

- Switch the electronic cash register to the "P" mode by pressing **4** **MODE**.
- Enter the number of the cashier you wish to correct and press **SKIFT** **EXP \$** (PASSWORD) key.
- Continue in the same way as shown in section above.
- You can print out data of all cashiers by pressing **CHECK** (CHECK) key. Press **UTBET EAN** key to print out data of the current cashier only.
- Finish the corrections by pressing **KONTANT** (TOTAL) key.

### Printing of cashiers values

To check the programmed names and other settings, press the **CHECK** (CHECK) key in the cashier programming. In the programming mode, press the **SKIFT** **EXP \$** (PASSWORD) key first and then press **CHECK** (CHECK) key. Print the programmed values of the current cashier by pressing the **UTBET EAN** (EAN) key.

## FUNCTION TEXTS PROGRAMMING

The Euro-2100TE allows you to program all the operation labels that can be displayed/printed to the receipt. The default values for all function texts are shown in the figure 3.21. You can adjust all of them to your needs.

**Figure 3.21 Default function texts**

Text no.	Default setting	Description
1	KONTANT	Cash payment denomination
2	CHECK	Check payment denomination
3	KORT	Credit card payment denomination
4	TILLBAKA	Change value denomination

5	RETUR	Refund value denomination
6	FELSLAG	Void denomination
7	INBETALT	Received on account denomination
8	UTBETALT	Paid out denomination
9	TOTALT	Total value
10	DOKUMENTNUMMER	Document number

Function texts programming procedure:

- 1) Switch the electronic cash register to the "P" mode by pressing .
- 2) Press the (VOID) key. Electronic cash register will display the number of the currently programmed function text in the second display row and contents of that text in the first display row.

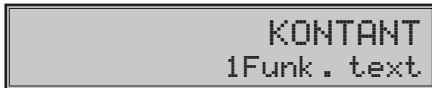

- 3) Enter new function text that could have up to 17 characters. If you mistyped, you can correct mistakes by pressing (CLEAR) key. Details on entering texts are located at the end of this chapter.
- 4) Press (SUBTOTAL) key to programme next available function text; continue with step 3). Finish the function texts programming by pressing (TOTAL) button at any time.

## Correction of function texts

- 1) Switch the electronic cash register to the "P" mode by pressing .
- 2) Enter the number of text to be corrected and press (VOID) key.
- 3) Continue in the same way as when programming function texts (consult section above).
- 4) Print out all programmed function texts by pressing (CHECK) key; print the currently edited function text by pressing (EAN) key.
- 5) Correction of function texts is finished by pressing (TOTAL) button.

## Function texts print out

To check the programmed function texts, press (CHECK) key in function texts programming mode. If in programming mode, press (VOID) key first and then the (CHECK) key. Print the value of a particular function text by pressing (EAN) key.

## DEPARTMENTS PROGRAMMING

The Euro-2100TE cash register has 30 departments (DPT) available. Each department has three basic components:

- 1) Price
- 2) Department flag
- 3) Name

Programming procedure:

- 1) Switch the electronic cash register to the "P" mode by pressing .
- 2) Press the (DPT) key. The current department number and the label ("PRICE") appear in the second line on the display to indicate department price programming. The programmed price appears in the first display row.



- 3) Enter the new department price (maximum eight digits, including decimals). If you mistype, you can correct your mistakes by pressing **CL** (CLEAR) key.
- 4) Press the **SUMMA** (SUBTOTAL) key to continue with programming the flag for the current department. The display shows current department number in the second display row together with label ("FLAG") to indicate department flag programming. The value of department's flag is shown in the first display row. Press **KONTANT** (TOTAL) key to stop department programming (next steps will not run).
- 5) Enter the department flag for the current department according to the figure 3.22. If you mistype, you can correct it using the **CL** (CLEAR) key.

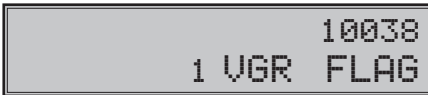

Figure 3.22 Department flag values

Digit	Default setting	Meaning	Valid values
1	1	Assigning VAT level to a department	1 – tax level 1, 2 – tax level 2, 3 – tax level 3, 4 – tax level 4,
2	0	Type of department	0 – normal, 1 – single item department
3	0	Negative department	0 – no, 1 – yes
4	3	Sale feature	0 – sale forbidden, 1 – open price (manually entered price), 2 – fixed price (preprogrammed price), 3 – 1+2 (preprogrammed price or the possibility to enter a price manually)
5	8	HALO limit, maximum 8 (maximum number of digits allowed)	1-8

- 6) Press **SUMMA** (SUBTOTAL) key to continue with programming the name for the current department. The electronic cash register display shows current department number along with the label ("name") in the second display row; first display row contains current department name on the right.



- 7) Enter the department name. If you mistype, you can correct your mistakes by pressing **CL** (CLEAR). See the end of chapter for more detailed instructions on entering texts.
- 8) Press the **SUMMA** (SUBTOTAL) to continue department programming for next department; proceed to step 3). and the programming of departments can be finished at any time by pressing **KONTANT** (TOTAL) key.

### Departments correcting

- 1) Switch the electronic cash register to the "P" mode by pressing **4** **MODE**.
- 2) Enter the number of the department you want to adjust (1 –30) and press **VGR** (DPT) key, or press the selected department button to directly choose required department.
- 3) Continue re-programming desired values as shown in the section above.

- 4) You can print out all the programmed department values by pressing (CHECK) key; to print out the currently programmed department, press (EAN) key.
- 5) Finish the corrections by pressing (TOTAL) key.

## Department values print out

Check the programmed department values by pressing the (CHECK) key in the department programming mode. In the programming mode, press the direct button of a department or a department number and then press the (DPT) button. Afterwards press the (CHECK) button. To print the settings of currently programmed department, press the (EAN) key.

## SALE UNITS PROGRAMMING

Sale unit can be assigned to each PLU and represents the unit in which the PLU is sold. It is possible to program eight sales units with up to three characters each. Figure 3.23 shows the default settings for sale units; you can adjust these defaults to your needs.

Sale units programming procedure:

- 1) Switch the electronic cash register to the “P” mode by pressing .
- 2) Press the (Value discount) key. The electronic cash register display shows the current sale unit number along with the label (“Förs .enhet.”) in the second display row and programmed unit in the first row.
- 3) Enter the text for the current sale unit (up to three characters). You can correct mistypes by pressing (CLEAR) key. See the section on entering texts at the end of this chapter.



Figure 3.23 Default sale units

Digit	Units	Digit	Units
1		5	m
2	st	6	m <sup>2</sup>
3	kg	7	fl
4	l	8	pkt

- 4) Press (SUBTOTAL) key to continue sale units programming with the next sale unit. Finish sales unit programming at any time by pressing the (TOTAL) key.

## Programmed sale units correcting

- 1) Switch the electronic cash register to the “P” mode by pressing .
- 2) Enter the number of the sales unit you want to modify and press (Value discount) key.
- 3) Continue the programming as described in the previous section (see above).
- 4) You can print out all programmed sale units by pressing (CHECK) key. To print the currently programmed sale unit, press (EAN) key.
- 5) Finish the corrections by pressing (TOTAL) key.

## Sale unit settings print out

If you want to check the settings of the sale units, press the (CHECK) key in the sale units programming mode. If the electronic cash register is in the programming mode, first press the (Value discount) key, then the (CHECK) key. For a printout of the current sale unit, press the (EAN) key.

## PLU WITH A SECOND PRICE AND TAX VALUE PROGRAMMING

The Euro-2100 can handle up to 16,000 PLU's, depending on the PLU number defined.

### Procedure for programming a PLU with two prices and tax levels:

- 1) 1st PLU price
- 2) assigning the 1st price to a tax level
- 3) 2nd PLU price
- 4) assigning the 2nd price to a tax level
- 5) flag number. 1
- 6) flag number. 2
- 7) PLU name
- 8) MIX&MATCH
- 9) PLU bar code (identification)

### Procedure when programming a PLU with two prices:

- 1) Enter P mode by pressing **4** **MODE**
- 2) If a particular PLU is to be programmed, enter its number from the PLU database. If no number is entered, programming will start from the first PLU. Press **PLU** and the PLU order number and the description "PLU PRIS 1" will appear on the display.



The LCD display shows the value 0.00 on the top line and the text "1 PLU PRIS1" on the bottom line.

- 3) Enter the first price for the PLU up to a maximum of eight digits, including the decimal numbers. An incorrect value can be deleted with the key **CL**.
- 4) The set value is saved by pressing the **SUMMA** key, and programming continues with the next tax value. The message "PLU MOMS 1" will appear on the display, with the actual tax level in the second row. Enter a value **1** - **4**, matching the tax level order number and save this value by pressing the **SUMMA** key. Upon entering a value the name - value of the tax will be displayed. If the **KONTANT** key is pressed, the programming of the tax level for the first price will be cancelled and the tax level set will be ignored. An incorrect value can be deleted with the key **CL**.



The LCD display shows the value 25.00% on the top line and the text "1 PLU MOMS1" on the bottom line.

- 5) After saving the value from the previous step, enter the second price for the PLU, up to a maximum eight digits including the decimal numbers. The PLU order number will appear in the first row and in the second row the description "PLU PRIS 2", with the actual value of the second price. Save this value by pressing the key **SUMMA** and continue programming the next parameter. An incorrect value can be deleted using the **CL** key.



The LCD display shows the value 0.00 on the top line and the text "1 PLU PRIS2" on the bottom line.

- 6) The next step is the programming of the second tax level. Enter a value **1** - **4**, matching the second tax level order number and save this value by pressing the **SUMMA** key. Upon entering value, the name - value of the tax to be used is displayed. Pressing the **KONTANT** key cancels the programming of the tax level for the first price and the tax level set will be ignored. An incorrect value can be deleted using the **CL** key.



The LCD display shows the value 25.00% on the top line and the text "1 PLU MOMS2" on the bottom line.

- 7) After setting and saving the second tax level, programming continues with the setting of the first PLU flag. The actual PLU flag will appear in the first row and the PLU order number will appear in the second row with the description "PLU FLAG1". Enter the value of the flag per figure number. 3.22. A PLU ranging from 1001-1015 should not be set to a department with a negative price. If the flag for a PLU is set to "descriptive", only the name of the PLU is printed without a price or an amount. After setting the first PLU flag, set the value by pressing the **SUMMA** key; cancel and leave the programming of this section using the **KONTANT** key or delete an incorrect value with the **CL** key.



Figure 3.24 Values for the first PLU flag

Number	Default value	Meaning	Valid values
1 - 2	01	Assigning of a PLU to a department group	1 - 30
3	0	Descriptive PLU	0 - no, 1 - yes
4	0	Type of PLU	0 - normal PLU, 1 - single item PLU
5	0	Sale feature	0 - sale forbidden, 1 - open price (manually entered price), 2 - fixed price (pre-programmed price), 3 - 1+2 (pre-programmed price or the possibility to enter a price manually)

- 8) After setting the first PLU flag, continue with programming of the second PLU flag. In the first row the actual second PLU flag will appear and the second row will display the PLU order number with the description "PLU FLAG2". Enter the value of the flag per figure number. 3.23. A PLU ranging from 1001-1015 cannot be linked to another PLU. After setting the PLU second flag, set the value by pressing the **SUMMA** key; cancel and leave the programming of this section using the **KONTANT** key or delete an incorrect value using the **CL** key.



Figure 3.25 Values for second PLU flag

Digit	Default setting	Meaning	Valid values
1 - 2	00	Assigning the sale of another PLU to the sale of an actual PLU (linked PLU)	00 - no linked PLU, 01 - PLU No. 1001 is linked, 02 to 15 - PLUs 1002-1015 are linked
3	1	Sales unit assigning	1 - The first sales unit assigning, 2 to 8 - assigning the sales unit 2 - 8
4	0	PLU stock information on PLU report	0 - no, 1 - yes
5	1	PLU sale possibility even if stock is negative	
6	1	Split pricing possibility	
7	8	HALO limit, maximum 8 (maximum number of digits allowed)	1-8

- 9) After setting the second PLU flag, the name of the PLU has to be set. The actual PLU name will appear on the first row of the display and the order number with the description "PLU NAME" will appear in the second row. Enter the name of the PLU in 20 digits or in 10 digits for double-size characters. Set

the value by pressing the **SUMMA** key; cancel and leave off programming of this section with the **KONTANT** key or delete an incorrect value using the **CL** key.

```

1 PLU NAMN
  
```

- 10) Next, the programming of the MIX&MATCH discount system continues. The order ID of the MIX&MATCH group appears in the first row, while the second row shows the PLU order number with the description "MIX&MATCH". Enter the value of the PLU Mix&Match assignment and set the value by pressing the **SUMMA** key; cancel and leave off programming of this section using the key **KONTANT** or delete an incorrect value with the **CL** key.

```

00
1 MIX&MATCH
  
```

- 11) Programming continues with the setting of the bar code identification of a PLU. The actual bar code value that identifies the PLU will be on the display, and the PLU order number with the description "PLU B-CODE" will appear in the second row. Enter the bar code as it is on the label and set the value by pressing the **SUMMA** key; cancel and leave off programming of this section by pressing the **KONTANT** key or delete an incorrect value with the key **CL**.

```

00000000000000000000
1 PLU EAN-K
  
```

- 12) If the entered bar code is already set to another PLU, the electronic cash register will prompt you to change this value by displaying the PLU information set to the bar code. On display will appear "EAN-KOD FINNS" and the number of the PLU already set to the entered bar **SUMMA** code. Enter the correct bar code and save the value by pressing the key; correct the value by pressing the **CL** key or finish programming by pressing the **KONTANT**

```

3. PLU
3 PLU B-CODE

1 EAN-KOD FINNS
3 PLU EAN-K
  
```

- 13) After setting the PLU bar code and pressing **SUMMA** the next PLU programming will start. To quit PLU programming press **KONTANT** or continue from step number. 3 for the next PLU.

If the **KONTANT** key is pressed to quit programming, the electronic cash register will display message "CODE SORT" notifying you that it is sorting the changed data; after a few seconds the electronic cash register will again be ready to use.

```

KOD SORTERAR
  
```

## Setting up the bar-code scanner

To secure a reliable functioning of bar code scanning it is important to program the scanner correctly and connect it properly to the cash register. Parameters of the bar code scanner setting:

- eight data bits

- none parity
- one stop bit
- transmission speed and terminal character is according to setting of the fifth electronic cash register's system flag

The default setting of flag number. 5 corresponds to Metrologic bar code scanners (MS 951, MS 6720, MS 7100, MS 860, MS 6130 and MS 9520). All you have to do is read the following bar codes from the scanner programming manual:

- 1) Enter/Exit
- 2) Recall Default
- 3) Enter/Exit

The electronic cash register is able to handle bar codes containing data for product weight. The format is the following: PP XXXX V MMMMM K; PP - prefix of bar code (28 or 29), XXXX - PLU number (0001-9999), V - scales check digit, MMMMM - product weight (3 decimal digits) and K - bar code check digit.

In the case of usage of scanner with keyboard wedge connector it is necessary to program the scanner as follow:

- 1) Enter/Exit
- 2) Emulation for PS/2
- 3) STX prefix
- 4) ETX suffix
- 5) Enter/Exit

## Quick PLU price programming

If you need to change only of the first price of several PLUs, you can do it easily using the following procedure:

- 1) Switch the electronic cash register to the "P" mode by pressing **4** **MODE**.
- 2) Enter the PLU number and press the **PRIS** (PRICE) button. If you don't enter any number, the electronic cash register will start from PLU no. 1. The PLU number and the label ("PRIS") appear in the second display row, current PLU price is displayed in the first row.



- 3) Enter the new price (maximum eight digits including decimals).
- 4) Press **SUMMA** (SUBTOTAL) key to continue in the price programming of the next PLU; proceed to step 3).
- 5) Press **KONTANT** (TOTAL) key to finish the quick PLU price programming.

## Quick PLU stock programming

The cash register also records stock information for each PLU. The PLU stock information can be changed to another value directly, or you can alter stock by operations in the registration mode.

- 1) Switch the electronic cash register to the "P" mode by pressing **4** **MODE**.
- 2) Enter the PLU number and press the **INBET VAG** (SCALES) key. If you didn't enter any number, the electronic cash register will start from PLU number. 1. The display shows current PLU number and label "PLU LAGER" in the second display row and the current stock for that PLU in the first row.



- 3) Enter stock value (up to nine digits, three decimal places including) and press:
  - **SUMMA** (SUBTOTAL) key to apply the entered number as the new stock value,
  - **KR-** (DISCOUNT) key to add the entered number to the current stock or,



- **%-** (PERCENT DISCOUNT) key to subtract the entered number from the current stock.

Maximum stock value is 999 999.999. If you enter integer amount, enter the number and just press **.**. After pressing any of the above three keys, the electronic cash register will continue with programming of the stock for the next PLU.

- 4) Press **KONTANT** (TOTAL) to finish the quick PLU stock programming.

## Correction of programmed PLUs

- 1) Switch the electronic cash register to the "P" mode by pressing **4** **MODE**.
- 2) Enter the PLU number and press the **PLU** (PLU) button. You can also use the bar-code scanner scanning the bar-code will jump to the said PLU. If same bar code is used for more PLUs you can choose the right one with **INBET VAG** (SCALES) and **EXP \$** (DRAWER) and confirm it with **UTBET EAN** (EAN). This mode is indicated with „Select.“ label in left down part of the display.
- 3) Continue programming the PLU values as described in the relevant section.
- 4) You can print out all programmed PLUs by pressing **CHECK** (CHECK) key or you could print out the currently programmed PLU by pressing **UTBET EAN** (EAN) key.
- 5) You can jump to any PLU using the procedure in step 2). Press **KONTANT** (TOTAL) key to finish correcting the PLUs.

## Programmed PLUs print out

To verify programmed values, print them by pressing the **CHECK** (CHECK) key in the PLU programming mode. If the cash register is in root programming mode, press the **PLU** (PLU) key and then the **CHECK** (CHECK) key. Only PLUs that have been programmed will be printed. It is possible to print the programmed value of a particular PLU by pressing **UTBET EAN** (EAN) key.

## Programming of the Mix&Match discount system

- 1) Switch the electronic cash register to "P" mode by pressing the keys **4** **MODE**.

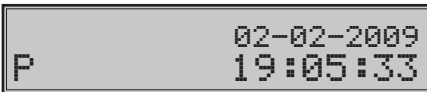

- 2) If a specific Mix&Match group is to be programmed, enter in the order number using keys **0** - **9** and press **KOPIA**. If no number is entered, the programming will start from the first Mix&Match group. The name of discount "MIX&MATCH DISC.01" will appear in the first row of the display and the second row will show the order number with the description "DISC. NAME".



- 3) Enter in 20 digits (or 10 if double-size characters are used), the name or the description of the Mix&Match group (for ex. "Holiday sale - %"). The procedure for entering text is described at end of this chapter. Incorrect characters can be deleted using the **CL** key.
- 4) After setting the name, press the **SUMMA** key to continue programming the amount of goods to which the Mix&Match discount will be applied. The actual amount set appears in the first row of the display and the second row will show the number of the discount with the description "QUANTITY". An incorrect value can be deleted using the **CL** key. To save the set value, press the **SUMMA** key.

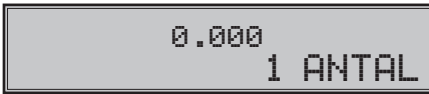

- 5) To set a value, press **SUMMA** and continue programming the value of the discount to be applied after reaching the value set in the previous step. The actual discount value set will appear on the display, and the second row will display the order number of the discount with the description "DISC.VALUE". An incorrect value can be deleted using the key **CL**. To save the set value, press the **SUMMA** key.



- 6) The final setting of a Mix&Match value is saved by pressing the **SUMMA** key. The setting of the Mix&Match group is completed once this value is set. Upon completion of this step, the programming of the next Mix&Match group will be started. To quit programming, press the **SUMMA** key.

## PROGRAMMING OF THE EURO CURRENCY

We advise you to read the sections "Basic terms regarding the Euro phase" and "payment in a foreign currency". The Euro-2100TE electronic cash register can perform accounting in a foreign currency and can also work with the special Euro phases during the change of the primary currency, including both the periods of dual display and dual currency circulation.

### Getting information about the actual Euro phase

Information regarding the actual Euro phase and the conversion setting can be read anytime from the electronic cash register by following this procedure:

- 1) Switch to programming mode by pressing key combination **4** **MODE**.
- 2) Enter **2** **0** **0** **0** **0** **YES**

Information regarding the actual Euro phase and currency settings will be printed on a receipt.

#### Important notice:

*Returning from any Euro phase to a previous phase is not possible without the master reset of the electronic cash register, which is performed by a service technician.*

### Default phase - using the main currency and a foreign currency

A new electronic cash register or an electronic cash register which has passed through master reset (performed by a service technician) is in this default phase. The electronic cash register can work with local currency (SEK) and any other foreign currency (EUR or USD).

**In this phase, the value and parameters for the foreign currency can be changed by following this procedure:**

- 1) Switch into programming mode by pressing the key combination **4** **MODE**.
- 2) Press the key **EXP**.
- 3) Enter the 3-character currency code (-for example: EUR) and press the **SUMMA** key to save this value. Then move to the next setting.
- 4) Enter the currency exchange rate such as: "1USD = xx.xxxx SEK". Press the **SUMMA** key to continue to the next step.
- 5) Enter the currency parameters regarding figure 3.22 and set the value using the key **SUMMA**.

*Notice:*

Parameters for foreign currency can be changed only after a Z-monthly report and an exchange rate can be changed only after a Z-daily report

**Figure 3.26 – Foreign currency parameters**

Digit	Default setting	Meaning	Valid values
1	0	Rounding method	0 – up from 5, 1 – always up, 2 – always down, 3 – special quarter rounding
2	2	Number. of decimal places for currency displaying	0 - 3
3	2	Number. of decimal places for currency rounding	0 - 2

## First Euro phase – the start of dual display

Dual display is used to print an informational currency conversion for the future currency at the bottom of each receipt. The dual displayed currency conversion has only an informational character and is not used for any other purpose. Each sale price will be converted to the new currency using the official conversion rate. The electronic cash register allows for the starting and stopping of dual display during any phase of the Euro changeover.

### Procedure for initiating dual display:

- 1) Switch into programming mode by pressing the key combination **4** **MODE**.
- 2) Enter the code **2** **0** **0** **1** **1** **⊗**.
- 3) Enter the conversion rate, such as: "1EUR = xx.xxxx SEK" and set this value using the key **SUMMA**.
- 4) Confirm the setting of the conversion rate by pressing the **SUMMA** key. After a successful setting, an informational receipt will be printed out:

Växlingskurs  
1EUR=10.4735 SEK  
Dubbel visnings av

- 5) Enter the code **2** **0** **0** **1** **2** **⊗** to start dual display.

An informational receipt will be printed out:

Växlingskurs  
1EUR=10.4735 SEK  
Dubbel visnings pa

### Note:

By entering the code **2** **0** **0** **1** **2** **⊗** again, dual display will be stopped/started.

### Warning:

A correctly entered conversion rate is the responsibility of the authorized electronic cash register operator and therefore be sure to check the correctness of the conversion rate.

## Second Euro phase – dual currency circulation

Upon changing to the second euro phase, the GT1, GT2 and GT3 will be automatically converted to the conversion rate of the new currency.

Upon entering this mode, dual display starts automatically, if it was not started in the past. During this phase, the electronic cash register operates with two currencies. The main currency will be the new currency (EUR) and the secondary currency will be the previous main currency (SEK).

The parameter of first system flag is set automatically to 002222 (a description of the first system flag is in



To use a different foreign currency, change to the third Euro phase is required. A description of how to do this is described in the next chapter.

## Third Euro phase

In this phase, a foreign currency (different than the SEK) can be set and used. Cancellation of dual display is not required in order to use a foreign currency. The main currency is the Euro, the dual-informational currency is the Swedish crown and the foreign currency is any other currency.

### Procedure for setting the foreign currency:

- 1) Execute a daily and monthly Z report.
- 2) Switch into programming mode by pressing the key combination **4** **MODE**.
- 3) Enter the code **2** **0** **0** **3** **☒**.
- 4) Enter the 3-character currency code (–e.g., USD); save this value and move to the next setting by pressing the key **SUMMA**.
- 5) Enter the currency exchange rate, such as: “1EUR = xx.xxxx USD”. Press the **SUMMA** key to go to the next step.
- 6) Enter the currency parameters as shown in figure 3.22 and set the value using the **SUMMA** key.

After programming of all values, a message showing the status of the third Euro phase setting will appear on the display and will also be printed out on an informational receipt:



### During the third Euro phase, the parameters can be set by following this procedure:

- 1) Switch into programming mode by pressing the key combination **4** **MODE**.
- 2) Press the **☒** key.
- 3) Enter the currency code and press **SUMMA**.
- 4) Enter the exchange rate regarding the new main currency and press **SUMMA**.
- 5) Enter the currency parameters per figure 3.22 and confirm the setting by pressing **SUMMA**.

#### Notice:

the name and parameter of the foreign currency can be changed after the execution of a monthly Z report and the value of the exchange rate can be changed after a daily Z report.

## ENTERING TEXTS INTO THE ELECTRONIC CASH REGISTER

The numerical keys are used in text programming (logo, PLU names, cashiers names etc.). There are numbers in the upper part of the keys and letters and other characters are in the lower part. In national versions, all letters and characters of the alphabet are on the keys. To enter a capital letter hold the **SKIFT** (SHIFT) key and press the relevant key. For instance, enter letter “a” by simply pressing the **8** **MARK** key, letter “F” by holding **SKIFT** and pressing the **9** **OP** key three times, number “5” by pressing the **5** **NUM** key four times, to get the space character press **00**. To enter an uppercase letter, first press the **SKIFT** (SHIFT) key. The **SKIFT** (SHIFT) key works

much like the CapsLock on the PC keyboard. Once it is pressed, the next letter will be uppercase without the requirement to hold down the **SHIFT** (SHIFT) key.

Characters that are not printed on the keys are „“ (2 × **00**), „,“ (3 × **00**), „<“ (4 × **00**), „>“ (5 × **00**), „=“ (6 × **00**), „?“ (7 × **00**) and „\$“ (8 × **00**).

If you want to print a double-spaced character, press the **SHIFT 00** key before each double-width character. A double-sized character is displayed as FULL BLOCK text, and it is necessary to be in double-sized letter input mode to edit such a character. Enter this mode by pressing **SHIFT** and the **00** key two times. The double-width character is displayed as character with space in front on the electronic cash register display. If the programmed text string has characters which are on the same key, press the particular key as needed, wait until a full character appears on the display, and then press the key again. If there are successive characters that belong to different keys, simply press the buttons in order without waiting. Mistakes caused when entering characters can be corrected by **CL** (CLEAR) key to clear the incorrect characters.

## PROGRAMMING LAYOUT OF THE FUNCTIONAL KEYBOARD

This function allows the user to define the key layout of the basic – built-in keyboard. To each key can be assigned any function from the predefined functionalities, such as, for example, the key **PLU** can be programmed to the key **VGR**.

Programming a functional keyboard is possible only with help of the PC software and by using the communication commands implemented in the Euro2A. Almost every key can be programmed, with the exception of special – functional keys. (see chapter 4. Exceptions to programming the keyboard). Each key can start two different operations, as with the following:

- first function - the function triggered without the **SHIFT** key and only with the specific key.
- second function - the function triggered with the **SHIFT** key and the specific key.

The standard layout of the Euro-2100TE contains 33 keys. Each key is identified by its position. The keys are identified from 1 to 66, with the keys from 1 to 33 have the first function and the keys from 34 to 66 have the second function triggered with the **SHIFT** key before pressing the functional key. The key with ID 1/34 will be positioned in the top left row.

### Key numbers for Euro-2100

1/34	2/35	3/36	4/37	5/38	6/39
7/40	8/41	9/42		10/43	11/44 MODE
12/45	13/46	14/47	15/48	16/49	17/50
18/51	19/52	20/53	21/54	22/55	23/56
24/57	25/58	26/59	27/60	28/61	
29/62 SHIFT	30/63	31/64	32/65	33/66	

<b>7</b> !"#%	<b>8</b> ABCAÄ&E	<b>9</b> DEF
<b>4</b> GHI	<b>5</b> JKL	<b>6</b> MNOÓ
<b>1</b> PQRS	<b>2</b> TUV	<b>3</b> WXYZ
<b>0</b> &()*+	<b>00</b> ☐	<b>.</b> -,;:@

Numeric keys

## List of programmable functional keys

The following figure shows the functions that can be assigned to the keys. The figure contains the key code used for identification when communicating with the PC software and the electronic cash register. Further below is the positioning of keys, which is the same as it is on the electronic cash register after a master reset or the first use of the electronic cash register.







Code		Meaning	Default key index	
dec.	hex.		E2100	E200
0	0x00	empty function	49, 44	46
48	0x30	digit 0	30/63	30/63
49	0x31	digit 1	25/58	23/56
50	0x32	digit 2	26/59	24/57
51	0x33	digit 3	27/60	25/58
52	0x34	digit 4	19/52	16/49
53	0x35	digit 5	20/53	17/50
54	0x36	digit 6	21/54	18/51
55	0x37	digit 7	13/46	9/42
56	0x38	digit 8	14/47	10/43
57	0x39	digit 9	15/48	11/44
111	0x6F	digit 00	31/64	31/64
106	0x6A	button „.' (DOT)	32/65	32/65
79	0x4F	DPT (VGR), key [-] for calculator	10/43	-
97	0x61	DPT 1 (VGR 1)	-	29
98	0x62	DPT 2 (VGR 2)	-	22
99	0x63	DPT 3 (VGR 3)	-	15
100	0x64	DPT 4 (VGR 4)	-	8
101	0x65	DPT 5 (VGR 5)	-	2
102	0x66	DPT 6 (VGR 6)	-	62
103	0x67	DPT 7 (VGR 7)	-	55
104	0x68	DPT 8 (VGR 8)	-	48
196	0xC4	DPT 9 (VGR 9)	-	41
197	0xC5	DPT 10 (VGR 10)	-	35
122	0x7A	Clear (CL)	1/34	1/34
110	0x6E	Void (FEL), key [-] (backspace) for calculator	7/40	7
121	0x79	EAN (EAN), key [+/-] for calculator	12	14
108	0x6C	Scales (VLG)	18	21
118	0x76	Drawer (\$) )	24	5
117	0x75	Paper feed	16	13
120	0x78	Multiply/Time (X/TID), key [*] for calculator	8/41	12/45
105	0x69	Price (PRIS)	17/50	26/59
112	0x70	PLU (PLU), key [+] for calculator	9	4
107	0x6B	Credit (KORT)	23/56	20
115	0x73	Check (CHECK)	22/55	19
109	0x6D	Subtotal (SUMMA)	28/61	27/60

116	0x74	Total (KONTANT), key [=] for calculator	33/66	33/66
114	0x72	Refund (RETUR)	5/38	40
44	0x2C	Paid out (UTBET)	45	47
46	0x2E	Received on account (INBET)	51	54
113	0x71	Password (EXP)	57	38
88	0x58	Duplicate (KOPIA)	6/39	39
45	0x2D	Percentual discount (%-)	3/36	53
61	0x3D	Percentual Add-on (%+)	-	-
200	0xC8	Value discount (KR-)	2/35	52
201	0xC9	Value Add-on (KR+)	-	-
62	0x3E	Second Price (MOMS SKIFT)	4/37	3/36
64	0x40	PLU price question	42	37

## PROGRAMMING OF THE PROGRAMMABLE KEYBOARD KEYS

This procedure describes how to programme the programmable electronic cash register keys. An individual key could be programmed with arbitrary keystroke sequence (function keys, up to 16) that will be generated when the programmed key is pressed in the future.

**The programming of keys starts in programming mode . Press the key you wish to program.**

1. The display shows the ID number of programmable key, the label „Key Name“ and the current name assigned to that key.
2. Enter a new name and confirm by pressing the  (SUBTOTAL) key. If you press  (SUBTOTAL) key without entering anything, you just confirm the previous assigned name. When you press  (TOTAL), the key programming procedure ends.
3. If you have changed name for the programmed key, the electronic cash register will update its settings and print the information about key name change on the receipt (ID number of programmed key and the data of changed parameter – label „Key Name“ and its newly programmed value).
4. The display will then show the ID number of the programmable key, information label for the function programming „01.Func“ and text description of the current key function.
5. Press  (MULTIPLY) key to enter the key programming mode. The display will ask you to press a key. By pressing a function key, you'll assign its value to the programmed key. Keep pressing to add further function keys to the programmable sequence or press the currently programmed key to finish programming and assign the programmed function sequence to that key. The electronic cash register will update the key definition and print the change information messages to both receipt and journal (this information includes programmed key ID number, record type „01.Key“, info label on function programming and its number „01.Func“ and the programmed function sequence). The electronic cash register then continues with programming of next key, or goes to the first key if the currently programmed key was the last one.
6. If you didn't enter into the key programming mode, then you can press  (SUBTOTAL) to confirm the current value and proceed to the next key (or the first key if you were on the last key) and the programming procedure continues again with step 1.
7. Press  (TOTAL) button to exit the programming mode.



## The key function deleting

You can delete function sequence assigned to a key if you press **CL** (CLEAR) key during step 4. of the programming procedure.

The display will show that you are about to delete the function sequence assigned to a key and awaits a confirmation. Press **CL** (CLEAR) key to delete the value or press **SUMMA** (SUBTOTAL) to cancel the deletion. When you cancel the deletion you can proceed with programming procedure as usual. If you decide to confirm deletion, the electronic cash register will delete the assigned function sequence assigned to that key and prints the information about deleted function (this information includes programmed key ID number, record type „01.Key“, info label on function programming and its number „01.Func“ and the keyword „deleted“). The programming procedure then continues normally.

## Printing of the programmed key name

The name of the programmed key will be printed if you press **UTBET EAN** (EAN) key during step 1 of the programming procedure.

The electronic cash register will print to both, receipt and journal following information on the key: ID number of the programmed key, parameter label „Key Name“ and current value of that parameter.

## Printing of the programmed key function

The function of the programmed key will be printed if you press **UTBET EAN** (EAN) key during step 4 of the programming procedure.

The electronic cash register will print to both, receipt and journal following information about the key: ID number of the programmed key and record type „01.Key“, parameter label „01.Func“ and text description of the current key function.

## Printing of the settings for all keys

You can print the settings for all electronic cash register key if you press **CHECK** (CHEQUE) key in either step 1 or step 4 of the programming procedure.

The display will show „Keyboard prog.“ label and the same will be printed to both, receipt and journal. For each key, the electronic cash register will print:

- ID number and record type: „01.Key“
- parameter label „Key Name“ and the name of the current key
- for each function in the current key's assigned function sequence will print number and label „1.Func“ and the current value of that function.



***OPERATION  
IN REGISTRATION MODE***

The functions that are described in the following chapters are used in the registration mode. All financial transactions are stored in this mode.

If the cash register allows you to use the training mode, you can try the following functions in the training mode first (sales data are not stored in the memory).

## **RECOMMENDED PROCEDURES AT THE BEGINNING OF THE DAY**

- 1) Check if there is enough paper on the printer roll for the day. Insert a new paper roll, if necessary.
- 2) Print out an "X" report and make sure that:
  - a) date and time are correct,
  - b) a daily report was executed.
- 3) Check whether there is enough cash in drawer.
- 4) Register the initial cash put into the drawer by entering cash value and pressing the  (RA) key.





## **STATUS AND FUNCTIONS THAT ARE REQUIRED TO KNOW BEFORE THE BEGINNING OF REGISTRATION**

If a key is used for two functions, choose the function in the lower part of the key by simply pressing the key and choose the function in the upper part of key by press the  (SHIFT) key and pressing the key.

### **Error warning: the Clear key**



If a function key is used incorrectly or the registration range is exceeded, the electronic cash register issues an error beep and an error message appears on the display. To recover and correct the condition, simply press the  (CLEAR) key. The error code is cleared from the display. Then enter the correct function or amount.

### **Cashier log in: the Password key**

The cash register can assign a secret identification number (password) for up to six cashiers. Cashier passwords, as well as names, are programmed in the programming mode. To use the cashier identification function, enter the numeric password and press the  (PASSWORD) key. For extra security, press the   button before the password entry. Display will show a "ÄNGE KOD!" label. The entered password numbers are not visible on the display at this time. If an incorrect password is entered, the electronic cash register beeps twice and remains locked. Enter the correct number and press the  (PASSWORD) key to unlock the cash register. The password protection prevents unauthorised use of electronic cash register. If the cashier's name has been programmed, it will be printed in the receipt header area after the cashier logs in.

*Note: The factory default password's are the order number's for each cashier account (1 for first cashier ... 6 for sixth cashier).*

### **Cashier log out: the Password key**

If the cash register has been protected from unauthorised use, the cashier should log out by pressing the   (PASSWORD) key after finishing of registration. Display shows the "ÄNGE KOD!" label and the cash register is locked until the correct password is entered and the  (PASSWORD) key is pressed. When the cash register is locked, registration cannot be performed and the cash drawer will not open. This function is used when changing cashiers or when a cashier leaves the electronic cash register.

### **Finish sale with cash, check and credit payment method**

The payment method for each purchase can be cash, check, credit or any combination of these. Before selecting a payment method, the payment value can be entered. If the entered amount does not fully cover

the required payment, the remaining sum will be displayed.

Only with payment by credit card is the purchase value not rounded at all. With any combined payment methods, the purchase value is rounded according to the first system flag.

*Example:*

*Example: If payment is with a credit card, the key  must be pressed, after which the sum without rounding will appear on the display. After again pressing the  key, the payment information will be passed to the payment terminal and after successful transfer, the payment is finished.*











*Notice:*

*The subtotal value is rounded according the first system flag.*

To purchase goods in R and T mode the CleanCash securing device must be connected.

## SAMPLES OF BASIC REGISTRATION PROCEDURES

- 1) Switch the cash register into the "R" mode:  , or into the training „T“ mode  
- 2) If needed, enter the password to log in.
- 3) Enter the PLU code of the registered item.
- 4) Press the  (PLU) key.
- 5) Repeat step 3 and 4 for each PLU.
- 6) Press the  (SUBTOTAL) key. Total amount of the sale (including the VAT value) appears on the display.
- 7) Announce the amount to the customer.
- 8) Enter the amount tendered by customer and press the corresponding payment button:  (CASH),  (CHEQUE),  (CREDIT).
- 9) The cash drawer opens. When the amount tendered is greater than the due amount, the electronic cash register will show the change.

10) Tear off the receipt and give it to your customer together with the change, if any.

**Figure 4.1. Sample sale receipt:**

1. Top graphic logo
2. Top text logo
3. Unique organization number
4. Time
5. Date
6. ECR number \* receipt order number
7. Operator name
8. PLU name
9. Sale price
10. Name of good
11. Selling amount and unit price.
- This is printed only if unit price equal to 1.*
12. Selling price
13. Tax information
14. Value of purchase covered with cash
15. Number of receipt (from daily range)
16. Check code (certified version)
17. Bottom text logo
18. Bottom graphic logo

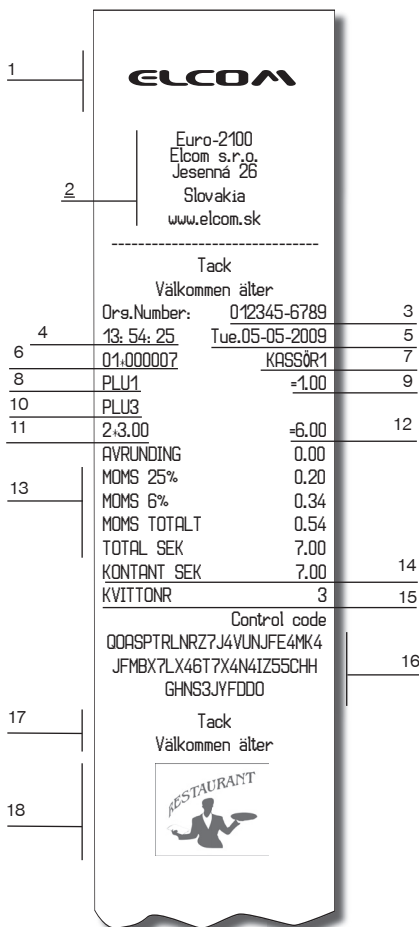

## REGISTRATION USING DEPARTMENTS

To get better information about revenue of particular items, split the articles into departments (article groups). The "department" means articles grouped in the same category (such as dairy products, pastry, alcohol etc.), or of the same tax level (MOMS 25%, MOMS 12%, VAT 16%, TAX 10% etc.). The Euro-2100TE cash register enables the use of a maximum of thirty departments. By default the department's are not programmed.

Item registration is finished by pressing the proper department key  $\boxed{\text{VGR 6}} - \boxed{\text{VGR 1}}$  or  $\boxed{\text{VGR 10}} - \boxed{\text{VGR 5}}$ . After pressing a department key, the registered amount, the corresponding tax level, the maximum registration amount, a pre-programmed price and others parameters are assigned to the revenue of the department. The sale informations are stored in the electronic cash register memory and used for department reports.

Numeric keys  $\boxed{0}$  -  $\boxed{9}$  and department keys  $\boxed{\text{VGR 6}} - \boxed{\text{VGR 1}}$  or  $\boxed{\text{VGR 10}} - \boxed{\text{VGR 5}}$  are used for registration (see keyboard picture). It is possible to register through departments by entering the department number and pressing the  $\boxed{\text{VGR}}$  (DPT) key ( $\boxed{5}$   $\boxed{\text{VGR}}$ ,  $\boxed{1}$   $\boxed{5}$   $\boxed{\text{VGR}}$ ...). Thus, you can register any department. It is also possible to register departments 1 to 10 by pressing a department keys  $\boxed{\text{VGR 6}} - \boxed{\text{VGR 1}}$  or  $\boxed{\text{SKIFT}} - \boxed{\text{VGR 10}} - \boxed{\text{VGR 5}}$ .

Step	Press
1.	<b>2</b> <b>7</b> <b>0</b> <b>0</b> <b>PRIS</b> <b>7</b> <b>VGR</b>
2.	<b>3</b> <b>1</b> <b>2</b> <b>0</b> <b>PRIS</b> <b>1</b> <b>0</b> <b>VGR</b>
3.	<b>SUMMA</b>
4.	<b>KONTANT</b>

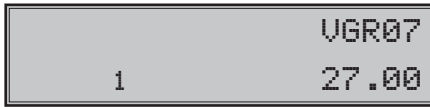

VGR 7	A
1:27.00	=-27.00
VGR 10	A
1:31.20	=-31.20
SUBTOTAL	58.20
-----	
BRUTTO MOMS 5%	58.20
NETTO MOMS 5%	55.43
MOMS 5%	2.77
TOTAL NETTO	55.43
TOTAL MOMS	2.77
TOTALT SEK	58.20
-----	
KONTANT SEK	58.20

### Basic registration using departments

The electronic cash register can be programmed to use pre-programmed price or the price entered from the keyboard during registration using departments. If both types are allowed, the cash register will use the price entered from the keyboard.

### Registration using departments with price entry from keyboard

- Using the **VGR** (Department) key
- Using the direct department keys **VGR 6** **VGR 1** – **SKIPT** **VGR 10** **VGR 5** which are not included by default but can be programmed with help of the communication software.

Step	Press
1.	<b>2</b> <b>4</b> <b>0</b> <b>0</b> <b>PRIS</b>
2.	<b>VGR 6</b> <b>VGR 1</b>
3.	<b>3</b> <b>1</b> <b>2</b> <b>0</b> <b>PRIS</b>
4.	<b>VGR 7</b> <b>VGR 2</b>
5.	<b>SUMMA</b>
6.	<b>KONTANT</b>

VGR 1	A
1:24.00	=-24.00
VGR 2	A
1:31.20	=-31.20
SUBTOTAL	55.20
-----	
BRUTTO MOMS 5%	55.20
NETTO MOMS 5%	52.57
MOMS 5%	2.63
TOTAL NETTO	52.57
TOTAL MOMS	2.63
TOTALT SEK	55.20
-----	
KONTANT SEK	55.20

## Registration using departments with pre-programmed price

Example: The pre-programmed price for DPT 1 is 7.50 and for DPT 2 is 43.20.

- Using the **VGR** (DPT) key

Step	Press
1.	<b>1</b> <b>VGR</b>
2.	<b>2</b> <b>VGR</b>
3.	<b>SUMMA</b>
4.	<b>KONTANT</b>

VGR 1	A
1:7.50	=7.50
VGR 2	A
1:43.20	=43.20
SUBTOTAL	50.70
-----	
BRUTTO MOMS 5%	50.70
NETTO MOMS 5%	48.29
MOMS 5%	2.41
TOTAL NETTO	48.29
TOTAL MOMS	2.41
TOTALT SEK	50.70
-----	
KONTANT SEK	50.70

- Using the direct department keys **KR-** - **SKIFT** **KOPIA**

Step	Press
1.	<b>VGR 6</b> <b>VGR 1</b>
2.	<b>VGR 7</b> <b>VGR 2</b>
3.	<b>SUMMA</b>
4.	<b>KONTANT</b>

VGR 1	A
1:7.50	=7.50
VGR 2	A
1:43.20	=43.20
SUBTOTAL	50.70
-----	
BRUTTO MOMS 5%	50.70
NETTO MOMS 5%	48.29
MOMS 5%	2.41
TOTAL NETTO	48.29
TOTAL MOMS	2.41
TOTALT SEK	50.70
-----	
KONTANT SEK	50.70

## Registering multiple items using departments

It is not necessary to enter the price repeatedly if more than one of the same item are being sold. After entering the unit price, just press the corresponding DPT key repeatedly for the number of sold items.

- Using the direct department keys **VGR 6** **VGR 1** - **SKIFT** **VGR 10** **VGR 5** which are not included by default but can be programmed with help of the communication software.

Step	Press
1.	<b>3</b> <b>1</b> <b>2</b> <b>0</b> <b>VGR 7</b> <b>VGR 2</b>
2.	<b>VGR 7</b> <b>VGR 2</b>
3.	<b>VGR</b>

VGR 2	A
1:31.20	=31.20
VGR 2	A
1:31.20	=31.20
VGR 2	A
1:31.20	=31.20



- Using the **VGR** (DPT) key

Step	Press
1.	<b>3</b> <b>1</b> <b>2</b> <b>0</b> <b>PRIS</b> <b>1</b> <b>6</b> <b>VGR</b>
2.	<b>VGR</b>
3.	<b>VGR</b>

VGR 16	A
1*31.20	=-31.20
VGR 16	A
1*31.20	=-31.20
VGR 16	A
1*31.20	=-31.20

## Items multiplying during registration using departments

- Multiplication of items with price entered via keyboard

The customer buys 12 pieces of the same items at 16.20:

Step	Press
1.	<b>1</b> <b>2</b> <b>⊗</b>
2.	<b>1</b> <b>6</b> <b>2</b> <b>0</b> <b>VGR 7</b> <b>VGR 2</b>
resp.	( <b>1</b> <b>6</b> <b>2</b> <b>0</b> <b>PRIS</b> <b>2</b> <b>VGR</b> )

VGR 2	A
12*16.20	=194.40

- Multiplication of items with pre-programmed price

Example: The customer buys 12 pieces of the same item with pre-programmed price of 14.20:

Step	Press
1.	<b>1</b> <b>2</b> <b>⊗</b>
2.	<b>%-</b>
resp.	( <b>2</b> <b>VGR</b> )

VGR 2	A
12*14.20	=170.40

This feature helps when you need to enter a large amount of items or you need to enter quantities that contain decimals (1.5, 0.125, etc.). Multiplication of numbers with a decimal point is often used for weighed items (meat, vegetables, salads, etc.) where the unit price is known (e. g. for 1 lb, for 1 litre, etc.). The largest allowed multiplicand is 10000.

## Registering fractions of items using departments

The cash register can be programmed for registration of split prices. This functionality is programmed by setting the second system flag, digit no. 6 to 0.

Example: The price is determined for a package that includes five pieces of the item (e. g. a box of processed cheese). The customer buys only three pieces, paying three fifths of the price of the whole box.







- Fractional entry with entering the price via keyboard

Step	Press
1.	<b>3</b> <b>⊗</b>
2.	<b>5</b> <b>⊗</b>
3.	<b>3</b> <b>1</b> <b>2</b> <b>0</b> <b>PRIS</b> <b>2</b> <b>VGR</b>

VGR 2	A
3/5*31.20	=18.70

DPT2/6 This key's are not included at default keyboard layout but can be programmed with help of the communication software.

- Fractional entry with pre-programmed price

Step	Press
1.	 
2.	 
3.	 

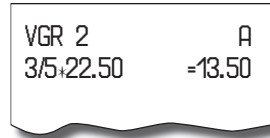











## Double multiplication of items during registration using departments

The cash register can be programmed for double price multiplication. The function is practical, for example, when entering a sale of items sold by area (square metres). This function must be programmed by setting the second system flag, digit no. 6 to 1.

- Double multiplication with entering the price via keyboard

Example: The price is determined for a square metres. Your customer buys a 3 by 5 metres piece.

DPT2/6 This key's are not included at default keyboard layout but can be programmed with help of the communication software.



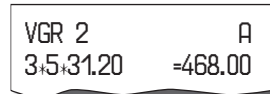



Step	Press
1.	 
2.	 
3.	      



- Double multiplication of items with pre-programmed price

Example: The pre-programmed price is 32.00 determined for a square metre. Your customer buys 3 by 5 metres.

DPT2/6 - These keys are not included in the default keyboard layout but can be programmed with help of the communication software.

Step	Press
1.	 
2.	 
3.	 

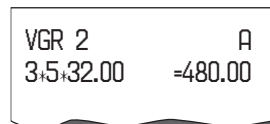

## Single item sales using departments

Some services often sell a single item (for example, cigarettes). To simplify the sale of such items, it is possible to programme the price into a department and set it up as single item sale department. Then, by pressing the department key, the item is automatically registered, the sale is automatically finished and the cash drawer is automatically opened. This group is called a single item sale group. In the following example, DPT 4 is programmed with the price of 2700.

If other transactions have already taken place before a single item sale, the transaction is not finalised and it is possible to continue with registration of other items.

- DPT2/6 - These keys are not included at default keyboard layout but can be programmed with help of the communication software.

Step	Press
1.	 

VGR 4	A
1:27.00	=-27.00
-----	
BRUTTO MOMS 5%	27.00
NETTO MOMS 5%	22.70
MOMS 5%	4.30
TOTAL NETTO	22.70
TOTAL MOMS	4.30
TOTALT SEK	27.00
-----	
KONTANT SEK	27.00







## PLU REGISTRATION

Articles have assigned codes (PLU numbers). For example, RAMA butter – PLU no. 5, Skimmed milk - 23, Rum 0.5 l - 189, etc. Data concerning the articles (name, price, assignment to the department, etc.) are programmed in the cash register memory and linked to a particular PLU number. Entering the PLU number and pressing the  (PLU) key looks up the data in the electronic cash register memory and registers it automatically.

PLU registration allows storing of information about the sale of each particular item, printing the names of articles automatically on the receipt, printing the unit price automatically and assigning the transaction to a department. It also prevents mistakes in keyboard registration. The name of each item on the receipt satisfies the customer for correctness of items purchased. By automatically calling programmed data from the cash register memory, faster customer service and greater accuracy is provided.

PLU registration makes it possible to get a clear overview of the sale of each particular item. A personal computer and a bar code scanner can supplement the advantages of PLU registration.

## Basic PLU registration

Step	Press
1.	 
2.	 
3.	
4.	

Bread
1      27.00

Bread	A
1:27.00	=-27.00
Butter	A
1:31.20	=-31.20
SUBTOTAL	58.20
-----	
BRUTTO MOMS 5%	58.20
NETTO MOMS 5%	55.43
MOMS 5%	2.77
TOTAL NETTO	55.43
TOTAL MOMS	2.77
TOTALT SEK	58.20
-----	
KONTANT SEK	58.20

## Multiplication in PLU registration

Example 1: The customer buys twelve pieces of the same PLU with the price of 2140 each.

Step	Press
1.	<input type="button" value="1"/> <input type="button" value="2"/> <input type="button" value="⊗"/>
2.	<input type="button" value="1"/> <input type="button" value="PLU"/>

Bread	A
12×21.40	=256.80

Example 2: The customer buys twelve pieces of the same PLU with entering the price of 2050 via keyboard.

This feature helps when you enter a large quantity of items or need to enter quantities that contain decimals (1.5, 0.125; etc.). Multiplication by numbers with the decimal part is often used by the weighed items (meat, vegetables, salads etc.) where the unit price is known (e. g. for 1 lb or for 1 litre, etc.). The maximum multiplicand is 10 000.

Step	Press
1.	<input type="button" value="1"/> <input type="button" value="2"/> <input type="button" value="⊗"/>
2.	<input type="button" value="2"/> <input type="button" value="0"/> <input type="button" value="5"/> <input type="button" value="0"/> <input type="button" value="PRIS"/>
3.	<input type="button" value="1"/> <input type="button" value="PLU"/>

Bread	A
12×20.50	=246.00

## Individual PLU registration

In some services, just a single item is often sold, e.g. cigarettes. To simplify the sale of such items, it is possible to program a single sale PLU flag (see PLUs programming). By entering the PLU number and the  (PLU) key, the item is registered, the sale is automatically finished and the drawer opened. This PLU is called a single sale PLU. PLU 4 is programmed with price 70.00 in the example.

Note: If other transactions have already been performed before the single item sale, then that sale does not complete the transaction. It is possible to continue registering of other items.

Step	Press
1.	<input type="button" value="4"/> <input type="button" value="PLU"/>

Cigarettes	A
1×70.00	=70.00
-----	
BRUTTO MOMS5%	70.00
NETTO MOMS 05%	66.67
MOMS 5%	3.33
TOTAL NETTO	66.67
TOTAL MOMS	3.33
TOTAL SEK	70.00
-----	
KONTANT SEK	70.00

## Overwriting the pre-programmed PLU price

Either the pre-programmed price or a price entered from the keyboard may be used for PLU registration. If both methods are allowed, the cash register uses the price entered from the keyboard.

Example: The customer has been given a special price, different from the pre-programmed one. PLU 3 has the pre-programmed price of 21.40, but the special price is 20.50.

Step	Press	
1.	$\boxed{2}$ $\boxed{0}$ $\boxed{5}$ $\boxed{0}$ $\boxed{PRIS}$	
2.	$\boxed{3}$ $\boxed{PLU}$	

### Fractional PLU registration

The function must be programmed by setting the second system flag, digit no. 6 to 0.

Example: The price is determined for packing including five pieces of the article (e. g. a box of processed cheese) at the price of 15.60. The customer buys only three pieces. Thus, he is to pay three fifths of the unit price of the whole box.

Step	Press	
1.	$\boxed{3}$ $\boxed{\otimes}$	
2.	$\boxed{5}$ $\boxed{\otimes}$	
3.	$\boxed{2}$ $\boxed{PLU}$	

### Double multiplication in PLU registration

The function must be programmed by setting the second system flag, digit no. 6 to 1.

Example: The price is determined for the a square metre. Your customer buys 3 by 5 meters.

Step	Press	
1.	$\boxed{3}$ $\boxed{\otimes}$	
2.	$\boxed{5}$ $\boxed{\otimes}$	
3.	$\boxed{2}$ $\boxed{PLU}$	

### Linked PLUs registration.

If sold item has first and second digit in second PLU flag (Figure 3.25) programmed, electronic cash register automatically continue in sale of linked item. This behaviour is used e.g. for sale of item with its returnable container.

Rules for linked PLUs registering:

- with void of main PLU is cancelled also linked PLU
- with refund of main PLU is refunded also linked PLU
- linked PLU is registered with same quantity as main PLU
- discount/surcharge applying on main PLU is not applied on linked PLU
- price for main PLU entered from the keyboard is not valid for linked PLU

### Quick PLU programming during sale

In case that during accounting an invalid PLU (PLU with flag "0-sale forbidden") is requested, the electronic cash register will show error message informing that the PLU is not active. This message can be canceled with key  $\boxed{SUMMA}$ .

EJ AKTIVT PLU

To continue accounting of different PLU press **CL**. To start programming PLU, press **SUMMA**

PROGRAM PLU  
J-ST/N-CL

1. As next, the electronic cash register will prompt to enter the number of department which will be printed as PLU name. To enter it, use the numeric pad of the keyboard. Set value and move forward with key **SUMMA**.

01  
3 PLU VGR

2. The electronic cash register will ask for used tax level. Enter the order number of the VAT **1** - **4**. Set value and move forward with key **SUMMA**.

25.00%  
3 MOMS SATS

3. Enter price of PLU, set value and move forward with key **SUMMA**.

0.00  
3 PRIS

Programming of quick PLU will start from the first item. To sell the PLU press key **PLU** or correct entered values and start from point 1.

## Use of Mix&Match discounts during a sale

The Mix&Match discount system is applied automatically; there is no need for the operator to initialize or confirm it. The discount is displayed as the next item with the discount value after passing the preset discount amount. The subtotal is calculated with the discount value included. If the discount group is not valid, the discount will be not applied; therefore check chapter 3.1 Conditions for applying a Mix&Match discount.

Exceptions: - if the sum of the goods to which the discount will be applied is less than the value of the discount, the discount will be not applied (see example no. 6 in the next chapter).

If a PLU is being refunded, the refunded product will not increase the amount (slovo si vynechal) of the sold goods required to apply the discount. (see receipt 7 in the examples).

The Cash register will apply a discount per the discount group setting each time a PLU is sold. To be certain about exactly how this works, see the examples below.

Namn="Discount 3for2"  
MINSTA ANTAL=3.000  
RABATT=2.00 SEK

**Example 1:**

PLU 1:
Namn: "COLA"
PRICE: 2.00
Assignment to Mix&Match group: 01
PLU 2:
Namn: "COLA LIGHT"
PRICE: 1.50
Assignment to Mix&Match group: 01

**Example 1:**

1 x COLA	2.00
1 x COLA	2.00
1 x COLA	2.00
1 x Discount 3for2	
RABATT	-2.00
-----	
. . .	
-----	
TOTAL	4.00
KONTANT	4.00

**Example 2:**

3 x COLA	6.00
1 x Discount 3for2	
RABATT	-2.00
-----	
. . .	
-----	
TOTAL	4.00
KONTANT	4.00

**Example 3:**

9 x COLA	18.00
3 x Discount 3for2	
RABATT	-6.00
-----	
. . .	
-----	
TOTAL	12.00
KONTANT	12.00

**Example 4:**

2 x COLA LIGHT	3.00
1 x COLA	2.00
1 x Discount 3for2	
RABATT	-2.00
-----	
. . .	
-----	
TOTAL	3.00
KONTANT	3.00

**Example 5:**

2 x COLA LIGHT	3.00
2 x COLA	4.00
1 x Discount 3for2	
RABATT	-2.00
-----	
. . .	
-----	
TOTAL	5.00
KONTANT	5.00

**Example 6:**

//exception - Mix&Match

2 x COLA LIGHT	0.90
2 x COLA	0.60
1 x Discount 3for2	
RABATT	-2.00
-----	
. . .	
-----	
TOTAL	1.50
KONTANT	1.50

//PLU sold with manually entered price

//discount will not be applied!

**Example 7:**

//exception - Mix&Match

2 x COLA LIGHT	3.00
2 x COLA	4.00
REFUND	
1 x PEPSI	-3.00
1 x Discount 3for2	
RABATT	-2.00
-----	
. . .	
-----	
TOTAL	1.50
KONTANT	1.50

//PLU sold with manually entered price

//discount will not be applied!

**Notice**

A Mix&Match discount is applied automatically at the end of a receipt even if another discount was manually applied at the PLU sale. (the PLU discount and also the Mix&Match discount will be applied).

Departments cannot be assigned to a Mix&Match discount group.

## Selling a PLU with a second price:

The electronic cash register allows a PLU to be sold with two different prices and tax levels. With a common sale, the default value is the first price and tax level.

When the key **MONS SKIFT** is pressed, an informational message will appear on the display –“SHIFT PRIS” and the next PLU will be sold with second price and tax level. To cancel the selling of a PLU with a second price and tax level, press the **CL** key and the message will disappear.

## Registration with customer number

Sale assigned to a customer is very important mainly in situations when the electronic cash register owner wishes to send the stored PC sale data to the PC and process them further. Processing of the data is determined by the PC application that identifies the customer and processes the data. You can enter the customer number by pressing key **START**, typing his/her number (of maximum eight digits) and pressing the **EXP \$** (**DRAWER**) key. Then you can continue sale as usual.

Example: Sale for the customer no. 312058.

Step	Press								
1.	<table border="1"> <tr> <td>UTBET EAN</td> <td>3 NOV</td> <td>1 POS</td> <td>2 TV</td> <td>0 ALT</td> <td>5 AL</td> <td>8 ANSLÅ</td> <td>EXP \$</td> </tr> </table>	UTBET EAN	3 NOV	1 POS	2 TV	0 ALT	5 AL	8 ANSLÅ	EXP \$
UTBET EAN	3 NOV	1 POS	2 TV	0 ALT	5 AL	8 ANSLÅ	EXP \$		
2.	<table border="1"> <tr> <td>1 POS</td> <td>PLU</td> </tr> </table>	1 POS	PLU						
1 POS	PLU								
3.	<table border="1"> <tr> <td>2 TV</td> <td>PLU</td> </tr> </table>	2 TV	PLU						
2 TV	PLU								
4.	<table border="1"> <tr> <td>SUMMA</td> </tr> </table>	SUMMA							
SUMMA									
5.	<table border="1"> <tr> <td>KONFANT</td> </tr> </table>	KONFANT							
KONFANT									

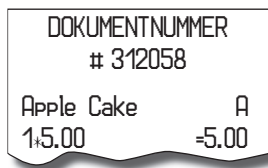

## Registration using bar-codes

- registration using a bar-code scanner

A bar-code scanner can be connected to the cash register. Information is then registered simply by scanning the bar-code on the article’s packaging. If the bar-code scanner is to operate correctly, it has to be properly configured and the electronic cash register has to have its relevant flags set to proper values, more specifically the fifth system flag (see PLU bar-codes programming section in the previous chapter).

Example: Customer buys three pieces of butter that have a bar codes on its packaging.

Step	Press		
1.	<table border="1"> <tr> <td>3 NOV</td> <td>3 NOV</td> </tr> </table>	3 NOV	3 NOV
3 NOV	3 NOV		
2.	using a bar-code scanner		

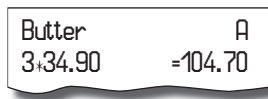

- registration by a bar-code entered via the keyboard

In the case of bar-code scanner failure or if a bar-code is damaged, it is possible to enter the bar-code via the keyboard.













Example 1: Registration of butter with the bar-code 8 586001 760096.

Step	Press									
1.	<table border="1"> <tr> <td>UTBET EAN</td> </tr> </table>	UTBET EAN								
UTBET EAN										
2.	<table border="1"> <tr> <td>8 ANSLÅ</td> <td>5 AL</td> <td>8 ANSLÅ</td> <td>6 NOV</td> <td>0 ALT</td> <td>0 ALT</td> <td>1 POS</td> <td>...</td> <td>6 NOV</td> </tr> </table>	8 ANSLÅ	5 AL	8 ANSLÅ	6 NOV	0 ALT	0 ALT	1 POS	...	6 NOV
8 ANSLÅ	5 AL	8 ANSLÅ	6 NOV	0 ALT	0 ALT	1 POS	...	6 NOV		
3.	<table border="1"> <tr> <td>UTBET EAN</td> </tr> </table>	UTBET EAN								
UTBET EAN										



Example 2: Registration of five butters with the bar-code 8 586001 760096.





Step	Press
1.	  
2.	
3.	       ... 
4.	



## Weight entry by electronic scales

The Euro-2100TE is able to read the weight of an article directly from connected electronic scales. Communication between the cash register and the scales is possible only in “R” and “T” mode. The electronic scales are connected to SCAN./SCALE connector of the cash register.

Press the  (SCALES) button to communicate with the scales. You can change the weight of the article (add or take the goods from the scales) until any key is pressed on the electronic cash register keyboard. After the weight is read by the cash register, enter the PLU number and press the  (PLU) button. If the weight on the scales is unstable, it is not possible to continue the sale.

In the case that electronic scale and scanner are connected together to one port and we want to register weight of a PLU article using scanner it is need to be pressed  (MULTIPLY) key before bar code of PLU is scanned.

Example: Registration of PLU no. 21 with weight 0.253 kg.

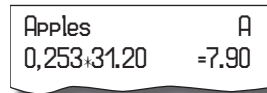

Step	Press
1.	
2.	reading of weight from scales
3.	  



To achieve the correct operation of the electronic scales, it is necessary to set the type of scales by programming the fifth system flag of cash register.

Ask your local dealer for more information on the particular electronic scales type connectivity.

## Connection of two electronic scales

Electronic scales can be connected to SCAN/SCALE connector and also to PC connector. This way is possible contemporary connection of two scales that is used in the case of necessity of weighing goods separately because of sanitary purposes (e.g. meat). Communication is activated (weight reading) with scales connected to PC connector after pressing the keys   (SCALES).

Once the scales communication is active it is possible to switch between scales in SCAN/SCALE connector and PC connector by pressing the  (SCALES) key. Actual scale communication is indicated in left bottom corner of display. For proper operation of electronic scales connected to PC connector it is necessary to program in programming mode type of connected electronic scales (seventh extended flag).

## Registration using an external PC keyboard

The standard PC keyboard can be easily connected to the Euro-2100TE. Registration is then similar as registration via the internal keyboard.

Figure 4.2 PC keyboard layout for the Euro-2100TE

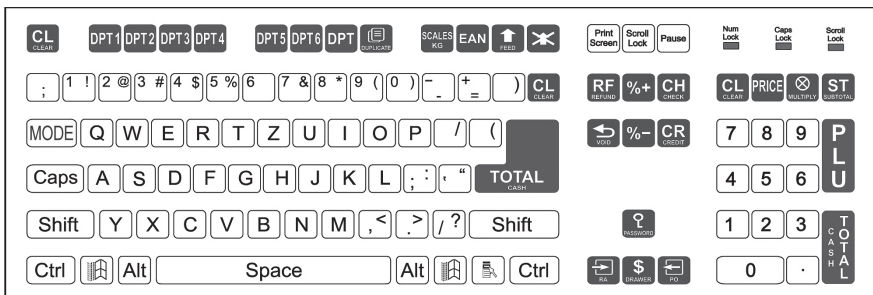

If one key is used for more characters, then the character in a lower part is chosen by pressing the actual key, the character in the upper part on the left side is chosen by pressing this key along with the Shift key and the character in the upper part on the right side is chosen by pressing this key along with the Alt key.

TAB key on the PC keyboard has the function of the mode.

Ask your local dealer for more information about external PC keyboard connection.

## CORRECTIONS

### Clearing

In the following example, the price 12.30 was incorrectly registered instead of 12.90

Step	Press
1.	
2.	
3.	

### Voidance

Void is used just to correct already sold items in the the non-finished sales.

- correction of the last entry (direct voidance)

Example: The previous item was registered incorrectly and it is necessary to make a correction. If a mistake is made in an incorrect department, PLU, percentage, deduction or other entry, void the incorrect entry by pressing the (Void) key immediately after the incorrect entry.

Step	Press
1.	
2.	
3.	

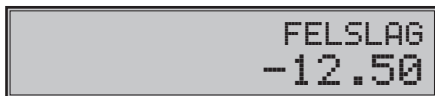

VGR 2	A
1:12.50	=-12.50
FELSLAG	
VGR 2	A
1:12.50	== -12.50
VGR 2	A
1:13.50	=-13.50

- correction of the previous entries (indirect voidance)

You can void any previous registrations. Pressing the special keys, you can display any previous registration.

Then press the (VOID) key. Special keys are: (jump to the previous), (jump to next),

(jump five items back) and **SKIFT** **INBET VAG** (jump five items forth). To search the item you have to start with **SKIFT** **EXP \$** (jump to the previous) or **EXP \$** (jump to next).

Example: Void the first PLU in the sale (Gentian Cheese).

Step	Press
1.	<b>3</b> <b>PLU</b>
2.	<b>2</b> <b>PLU</b>
3.	<b>SKIFT</b> <b>EXP \$</b> (search the item)
4.	<b>FEL</b>

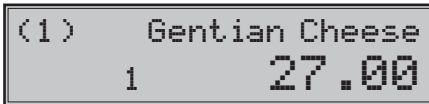

- voidance of receipt (subtotal voidance)

Example: Void the whole receipt. Subtotal voidance is used for total voidance of a sale. It can be used only before pressing the **KONTANT** (TOTAL) key.

Step	Press
1.	<b>1</b> <b>VGR</b>
2.	<b>2</b> <b>VGR</b>
3.	<b>6</b> <b>VGR</b>
4.	<b>SUMMA</b>
5.	<b>FEL</b>
6.	<b>SUMMA</b>

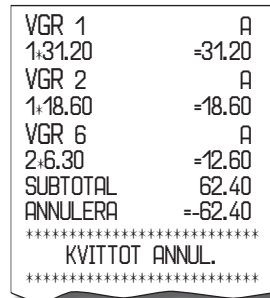

## PERCENTAGE AND VALUE SURCHARGE

A percentage and value surcharge can be entered from an external keyboard. The system permits programming of a percent value that is used for a discount **SKIFT** **KORT** and limits for manual entry. If you need to register a different rate than the one pre-programmed, enter the numeric value of the surcharge or of the discount before pressing the relevant key. The value of the new rate will be effective only for one registration.

## Percent surcharge

Example 1: A five percent surcharge for special services is added. In the following example the (programmed SURCHARGE) key was programmed for five percent. SKIFT CHECK

Step	Press
1.	<span>3</span> <span>1</span> <span>2</span> <span>0</span> <span>2</span> VGR <small>WGT FOR TW 0% %</small>
2.	SKIFT CHECK

PASLAG%+  
1.60

VGR 2	A
1+31.20	=31.20
PASLAG %+	5.00%
	=1.60

If all items within a transaction have the same handling charge, the charge may be added at one time for the whole transaction. When all items have been registered on which the surcharge is applied, press the SUMMA (SUBTOTAL) and then the SKIFT CHECK (SURCHARGE) key.

Example 2: Enter other than pre-programmed rate (10 %).

Entering the surcharge value from the keyboard is possible only if the value is lower than the pre-programmed limit (see seventh system flag).

In the case of a linked PLU, the surcharge is applied to the first item only.

Step	Press
1.	<span>3</span> <span>1</span> <span>2</span> <span>0</span> <span>2</span> VGR <small>WGT FOR TW 0% %</small>
2.	<span>1</span> <span>0</span> SKIFT CHECK <small>FOR 0% %</small>

VGR 2	A
1+31.20	=31.20
PASLAG %+	10%
	=3.10

## Percent discount

Example: Pensioners are provided with a 10% discount.

Step	Press
1.	<span>3</span> <span>1</span> <span>2</span> <span>0</span> VGR 7 VGR 2 <small>WGT FOR TW 0% %</small>
2.	%-

RABATT%-  
-3.10

VGR 2	A
1+31.20	=31.20
RABATT %-	10.00%
	=-3.10

If the same discount is to be deducted from all PLUs within the transaction, the discount for the whole transaction may be entered in one operation. When all items on which the discount is to be applied are registered, simply press the SUMMA (SUBTOTAL) key, then the %- (DISCOUNT) key. Use of other than pre-programmed percent discounts is the same as a percent surcharge.

Entering the discount value from the keyboard is possible only if the value is lower than the pre-programmed limit (see eighth system flag).

In the case of a linked PLU, the discount is applied to the first item only.

## Value discount

### Value surcharge and discount

It is possible to apply a value surcharge or discount on the last registered item, or on a whole sale.

The value of a surcharge or discount cannot be more than the price of the item or group of items to which the surcharge or discount is to be applied.

Example no. 1: Applying a value surcharge 2.00

Step	Press
1.	<b>3</b> <b>1</b> <b>2</b> <b>0</b> <b>2</b> VGR <small>MRZ FORS TW AC-C MR</small>
2.	<b>2</b> <b>0</b> <b>0</b> KR- <small>TR AC-C AC-C</small>

VGR02	=31.20
RABATT -	=-2.00

-2.00
RABATT -

### Percentage and value surcharge

A percentage and value surcharge is applied as the discount and can be entered only from an external keyboard; see "Registration using an external PC keyboard".

## PLU PRICE LOOKUP

### Quick PLU information lookup

In R and T mode, even at an open sale, it is possible to check a price before selling. This is done by pressing the key combination **SKIFT** **PLU**. The electronic cash register will prompt you to enter the PLU number. This can be done in three different ways:

1. **0** **9** **PLU** (or direct PLU key from a programmable keyboard)
2. by scanning the bar code
3. by pressing the key **UTBET EAN** and entering the bar code manually, and then pressing the **UTBET EAN** key again.

Next, the first price of the PLU will be displayed. Switch between the first and second prices of a PLU and the name of a PLU, EAN with the key **SUMMA** (SUBTOTAL).

This PLU can be sold by pressing the key **\***, entering multiplicative amount, and pressing the key **\*** (entering the amount is not necessary).

To quit the lookup function, press the key combination **SKIFT** **PLU**.

Cash register allows to find out the price of PLU article in „R“ and „T“ mode(also during open receipt). Price is checked by pressing the keys **SKIFT** **PLU** (SHIFT PLU), cash register ask to enter PLU code. There are 3 ways for code entry:

1. „number“ + **PLU** (PLU) (or direct PLU from programmable keyboard)
2. scan bar code with scanner
3. press **UTBET EAN** (EAN) key, enter bar code manually and press **UTBET EAN** (EAN) key









Consequently price of current PLU is displayed. Switching between displayed price, name of PLU and bar code is possible by pressing key **SUMMA** (SUBTOTAL). Registering of displayed PLU is possible by pressing the key **⊗** (MULTIPLY) or entering quantity (integral number) and pressing key **⊗** (MULTIPLY). Exit of PLU price lookup operation without registering PLU is possible by pressing the keys **SKIFT** **PLU** (SHIFT PLU).

## REFERENCE NUMBER OR CUSTOMER NUMBER PRINTING

Certain transactions require that a reference number is printed on the receipt. If a reference number is required, enter number and finish it with  (DRAWER) key.

Maximum length of reference number is 8 digits.

The text „DOKUMENTNUMMER“ can be changed in the programming mode. See Function texts programming section.









Step	Press
1.	
2.	      



## RECEIVED ON ACCOUNT

The  (RA) key is used to record non-fiscal payments (that are received on account). As an example, daily initial cash can be entered into the cash register drawer. The register enables printing a document that confirms the receive on account transaction. The RA transactions are reported in the cash register financial report. According to your needs, the document can contain the name of the person that performed the RA and the reason for the RA. The name and reason of an RA can contain up to 24 characters. There is space for a signature on the document.

Entry of person name and reason is not mandatory. If you do not need to enter these data, finish RA operation by double pressing of the  (SUBTOTAL) key.

Step	Press
1.	     
2.	
3.	enter name
4.	
5.	enter reason
6.	

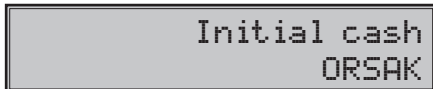
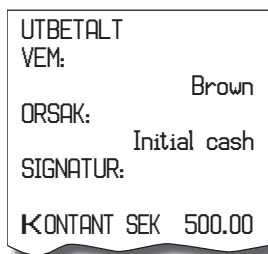

## PAID OUT (CASH OR CHEQUE)

Cash or cheques paid out from the register drawer that is not connected with a sale is recorded using the  (PO) key. This function is used, for example, to take away revenue, when cashiers are changing, or when it is suitable to lower the amount of money in the drawer. According to your needs, the document can

contain the name of a person and the reason for the PO operation. The name and reason of the PO can contain up to 24 characters. There is space for a signature on the document.

Entry of a name and a reason is not mandatory. If you do not need to enter these data, finish the PO operation by double pressing the **SUMMA** (SUBTOTAL) key.

To Paid Out cheques press **CHECK** (CHEQUE) instead of **KONTANT** (TOTAL) in step 2.

Step	Press
1.	<b>2</b> <b>0</b> <b>0</b> <b>0</b> <b>0</b> <b>0</b> <b>0</b> <b>SKIFT</b> <b>UTBET EAN</b>
2.	<b>KONTANT</b>
3.	enter name
4.	<b>SUMMA</b>
5.	enter reason
6.	<b>SUMMA</b>

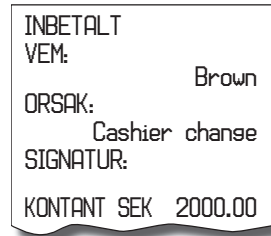

## REFUNDS

The **FEL** (VOID) key are used to correct an item that has already been registered. Use the VOID key if you want to erase the latest registered item.

Example 1: Erase the latest registered item, PLU 1.

Step	Press
1.	<b>1</b> <b>PLU</b>
2.	<b>FEL</b>

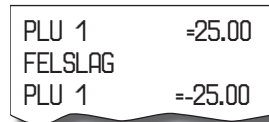

Example 2: Erase an earlier registered item, PLU 1. Use the EXP key to browse between the items.

Step	Press
1.	<b>1</b> <b>PLU</b> <b>2</b> <b>PLU</b>
2.	<b>EXP \$</b>
3.	<b>FEL</b>

## Operation in registration mode

---

A refund on a finished sale has to be done as an independent operation. When pressing the **RETUR** (REFUND) key, the "RETUR" label appears on the display. Handle the refund operation as a normal sale.

Example 3: Returning of five pieces of the same item registered under PLU no. 13.

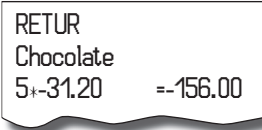
Step	Press	
1.	<b>RETUR</b>	
2.	<b>5</b> <b>PLU</b> <b>13</b> <b>PLU</b>	
3.	<b>KONTANT</b>	

Example 4: Returning of goods registered under PLU no. 13 and DPT no. 5 with entering of price via keyboard. Payment was made with a credit card.

Step	Press	
1.	<b>RETUR</b>	
2.	<b>1</b> <b>3</b> <b>PLU</b>	
3.	<b>2</b> <b>0</b> <b>PRIS</b> <b>5</b> <b>VGR</b>	
4.	<b>KORT</b>	

## NON-FINANCIAL PLU MOVEMENTS

There are four submodes in the registration mode that allow us to enter non-financial PLU movements. These non-financial movements include:

- receive on stock (stock increases),





- hand out from stock (stock decreases),



- orders (stock doesn't change) and



- inventories (stock doesn't change).



Operations in these submodes do not influence financial counters (grand totals, taxes, sale values for PLU, DPT or cashiers). Operations „receive on stock“ and „hand out from stock“ does affect PLUs stock level. As compared to the registration mode, some operations are forbidden in the non-financial movements submodes: registration using departments, refunds, surcharges, and discounts.

- 1) In registration mode, enter following key sequences to access the submodes:

  (ONE SUBTOTAL) for receive on stock submode,

  (TWO SUBTOTAL) for hand out from stock submode,

  (THREE SUBTOTAL) for orders submode and

  (FOUR SUBTOTAL) for inventory submode.

- 2) Register individual articles within chosen submode so as you would a normal sale (excluding the operations mentioned above).

- 3) Exit chosen submode by pressing   (FIVE SUBTOTAL).

Receipts issued in the respective submodes are clearly labelled with the submode operation name. Overall informations on the operations done in the non-financial movement submodes are gathered in the PLU report and cashiers report.

If the second extended flag, digit no. 1 is set to 2 and digit no. 2 is set to 1, then handing out from stock is also conditioned by assigning an existing customer number, that is checked against descriptive PLUs database. Only if the customer is assigned and validated, you can start handing out from stock. To check for the customer number, the descriptive PLUs are used: the descriptive PLU name has to contain maximum eight-digit number that is identical to the customer number. If the customer number contains less than eight numerals, it is fill up from left by zeros (e. g. customer number 5682 becomes to 00005682).

## ACCOUNTING DURING THE EURO PHASES

Before reading this chapter, it would be helpful to read the chapter “Basic terms regarding introduction of the Euro currency” and also “Accounting with a foreign currency”.

The Euro-2100TE electronic cash register can handle accounting with a main and a foreign currency and also works with special Euro phases designed for the changeover of the main currency, which includes dual display and dual currency circulation.

### Important notice :

- The electronic cash register can work with the main currency, a secondary (foreign or conversion currency) and a third currency for printing and displaying of information during the conversion period.
- Combined payment methods like cash, check and credit are allowed only with the main currency.

- In the foreign – dual currency, only cash payment, received on account and pay out operations are allowed.
- By combining local and foreign (dual) currencies, the cash back value is in the main – local currency even when paying with a foreign currency.
- To switch between currencies, the electronic cash register should have the foreign currency programmed or the Euro phase should be started.
- The change of the currency can be done after pressing the **SUMMA** (SUBTOTAL) key along with the **PRIS** (PRICE) key. After pressing the **PRIS** (PRICE), key, the switched – main currency in which the subsequent operations will be recorded appears on the display. Switching back to the main currency can be done by pressing the **PRIS** (PRICE) key again. If the **PRIS** (PRICE) key is not pressed, the currency will be the actual main currency.
- The main currency can differ during the Euro phases.
- Switching the currency with the **PRIS** (PRICE) key, as the exchange rate for conversion will be the programmed value in the setting of the foreign currency or the conversion rate during Euro phase.
- All operations with both local and foreign (dual) currencies such as payment with cash, check, credit, paid out and received on account, are recorded separately and printed separately on reports for each currency.

## Use of a foreign currency

Before using a foreign currency, this must be programmed. The programming procedure is included in the programming section of this manual.

### Procedure:

After pressing the **SUMMA** (SUBTOTAL) key, the purchase value in local currency will appear on the display. By pressing the **PRIS** (PRICE) key, this value will then be calculated according to the **PRIS** (PRICE) set exchange rate for the foreign currency. If the (PRICE) key is pressed one more time, the value will be switched back to the local currency. After switching to the correct currency, the payment value and the payment method can be chosen. Any payment method can be used with local currency, though only cash payment is allowed in a foreign currency.

Example: Buying a jacket for 870 SEK. The customer will pay 20 EUR with cash, 350 SEK with a credit card and the rest with cash in SEK.

### Procedure:

After registering all items

Step	Press
1.	<b>SUMMA</b>
2.	<b>PRIS</b>
3.	<b>2</b> <b>0</b> <b>0</b> <b>0</b> <b>KONTANT</b> or. <b>2</b> <b>0</b> <b>0</b> <b>0</b> <b>KONTANT</b>
4.	<b>PRIS</b>
5.	<b>3</b> <b>5</b> <b>0</b> <b>0</b> <b>KORT</b> or. <b>3</b> <b>5</b> <b>0</b> <b>0</b> <b>KORT</b>
6.	<b>KONTANT</b>

08: 42: 13	Tue. 05-05-2009
01.000002	CASHIER1
Black coat	=870.00
SUBTOTAL	870.00
-----	
AVRUNDING	0.00
MOMS 25%	174.00
TOTAL MOMS	174.00
TOTALT SEK	870.00
-----	
Växlingskurs	
1EUR=10.4700 SEK	
TOTAL EUR	83.09
KONTANT EUR	20.00
KORT SEK	350.00
KONTANT SEK	310.00
-----	
KVITTONR	3

Example: Receive on account of 500,00 €

Step	Press
1.	<input type="button" value="PRIS"/>
2.	<input type="button" value="5"/> <input type="button" value="0"/> <input type="button" value="0"/> <input type="button" value="0"/> <input type="button" value="0"/> <input type="button" value="SKIFT"/> <input type="button" value="INBET VAG"/>
	or. <input type="button" value="5"/> <input type="button" value="0"/> <input type="button" value="0"/> <input type="button" value="."/> <input type="button" value="SKIFT"/> <input type="button" value="INBET VAG"/>
3.	<input type="button" value="KONTANT"/>
4.	enter name (not necessary)
5.	<input type="button" value="SUMMA"/>
6.	enter reason (not necessary)
7.	<input type="button" value="SUMMA"/>

UTBETALT  
VEM: Brown

ORSAK: Initial cash

SIGNATUR:

KONTANT EUR 500.00

## The first Euro phase - dual currency display

Dual currency display can be started after the official declaration of the exchange rate by the authorities. After starting this phase, the informational conversion will be displayed and printed out on the bottom of each receipt to inform about the relation between the main (local currency) and the future currency.

The procedure for how to set this is described in the programming section of this manual.

In this phase, the electronic cash register is working with three currencies. The main currency is the actual, local currency. The dual currency is the future currency that will be used (EUR) and third, foreign currency can be used for payment (this could also be the Euro with an individual exchange rate). The dual currency is used only for dual display, which is calculated according to the official exchange rate. Only cash payments are allowed in the foreign currency. Cash back is handled in the local currency. The dual display currency and the foreign currency can have the same name with a different exchange rate. The second currency can have an exchange rate declared by the government and the foreign currency can have the individual market rate.

TOTALT SEK	870.00
<hr style="border-top: 1px dashed black;"/>	
Inform. beräkning	
TOTALT EUR	83.07
Växlingskurs	
1EUR=10.4735 SEK	
<hr style="border-top: 1px dashed black;"/>	
Val.kurs	
1EUR=10.2365 SEK	
TOTALT EUR	84.99
KONTANT EUR	30.00
KONTANT SEK	563.00

## The second Euro phase

The electronic cash register is working only with two currencies, the main currency – the EUR – and the secondary (foreign) currency – the SEK. A third foreign currency cannot be used. The main currency could be, for example, the Euro and the secondary currency the Swedish crown. During payment, both currencies can be used and cash handed back will be only in the main currency – the Euro.

Before first use of the electronic cash register in the second Euro phase, each PLU and DPT price has to be converted to the new currency, manually or with help of the PC communication software. The cumulative sum – GT is converted automatically on the basis of the conversion rate.

### Payment in second Euro phase

Upon pressing the **SUMMA** (SUBTOTAL) key during a sale, the displayed purchase value is displayed in the main currency (Euro). If the key **PRIS** (PRICE) is pressed, the purchase value is converted to the secondary currency – the SEK – on basis of the conversion rate. If the [Price] key is pressed again, the price will again appear in the local currency – the EUR. After the currency is selected, subsequent operation will be done in the chosen currency. Only cash payment is allowed in the secondary currency. The cash back value in this phase is in the main currency – the EUR.

Example: Buying a jacket for 80 EUR. The customer will pay 20 EUR with cash, 20 EUR with credit and the rest with cash in secondary currency – SEK.

Procedure:

After registering all goods

Step	Press
1.	<b>SUMMA</b>
2.	<b>2 0 0 0 0</b> <b>KONTANT</b> or. <b>2 0 0 0</b> <b>KONTANT</b>
3.	<b>2 0 0 0</b> <b>KORT</b> or. <b>2 0</b> <b>KORT</b>
4.	<b>PRIS</b>
5.	<b>KONTANT</b>

Black coat	80.00
SUBTOTAL	80.00
-----	
MOMS 25%	16.00
MOMS TOTAL	16.00
TOTALT EUR	80.00
-----	
Inform. beräkning	
TOTALT SEK	837.00
Växlingskurs	
1EUR=10.4735 SEK	
-----	
KONTANT EUR	20.00
KORT EUR	20.00
Val.kurs	
1EUR=10.2365 SEK	
KONTANT SEK	419.00

Example: Paid out of 2 000,00 SEK in second Euro phase.

Step	Press
1.	<b>PRIS</b>
2.	<b>2 0 0 0 0 0 0</b> <b>SKIFT INBET VAG</b> or. <b>2 0 0 0</b> <b>SKIFT INBET VAG</b>
3.	<b>KONTANT</b>
4.	enter name (not necessary)
5.	<b>SUMMA</b>
6.	enter reason (not necessary)
7.	<b>SUMMA</b>

UTBETALT	
VEM:	Brown
ORSAK:	Initial cash
SIGNATUR:	
KONTANT	SEK 2000.00

## The third Euro phase

The main currency is the Euro currency and the Swedish crown is the currency for informational conversion and display and the third currency can be any other foreign currency. Payment or value transfer operations can be done with the foreign currency. The displayed dual currency is used only for informational displaying of the currency conversion.

### Procedure for registering:

By pressing the key **SUMMA** (SUBTOTAL) during a sale, the displayed purchase value is displayed in the main currency (Euro). If the key **PRIS** (PRICE) is pressed, the purchase value is converted to the secondary currency – the SEK – on the basis of the conversion rate. If the key [Price] is pressed again, the price will appear in the local currency – the EUR. After choosing the currency, subsequent operations will be recorded in that currency.

Example: Buying a jacket for 80 EUR. The customer will pay 30\$ cash, 20 EUR with credit and the rest with cash in Euro.

Procedure:

After registering of all goods

Step	Press
1.	<b>SUMMA</b>
2.	<b>PRIS</b>
3.	<b>3</b> <b>0</b> <b>0</b> <b>0</b> <b>KONTANT</b> <small>WTC</small> <small>EUR</small> <small>EUR</small> <small>EUR</small>
	OR. <b>3</b> <b>0</b> <b>.</b> <b>KONTANT</b> <small>WTC</small> <small>EUR</small> <small>SEK</small>
4.	<b>PRIS</b>
5.	<b>2</b> <b>0</b> <b>0</b> <b>0</b> <b>KORT</b> <small>WTC</small> <small>EUR</small> <small>EUR</small> <small>EUR</small>
	OR. <b>2</b> <b>0</b> <b>.</b> <b>KORT</b> <small>WTC</small> <small>EUR</small> <small>SEK</small>
6.	<b>KONTANT</b>

Black coat	80.00
SUBTOTAL	80.00
-----	
MOMS 25%	16.00
TOTAL MOMS	16.00
TOTAL EUR	80.00
-----	
Inform. beräkning	
TOTAL SEK	837.00
Växlingskurs	
1EUR=10.4735 SEK	
-----	
Valkurs	
1EUR=1.45670 USD	
TOTALT USD	116.54
KONTANT USD	30.00
KORD EUR	20.00
KONTANT SEK	39.41

### Completion of dual display of informational currency conversion

After completion of the dual display period, the main currency will be the Euro, and the secondary currency can be any other foreign currency and no informational conversion will be displayed. Setting this phase is described in the programming section of this manual.



# ***REPORTS***

## HOW TO PRINT OUT REPORTS

There are two modes for printing reports: "X" mode and "Z" mode.

Use "X" mode reports if it is necessary to obtain sales information since the last resetting. It is used to generate reports during the day, between two shifts, etc. The reading may be made in any numbers, it does not affect the cash register memory.

Use "Z" mode reports when you need to print reports and to clear the register's memory. "Z" report is usually carried out once a day after finalising the daily sales.

## GENERATED REPORTS

Table 5.1. Generated reports

Report	"X" mode	"Z" mode
Department	•	
PLU	•	•
PLU Stock	•	
Cashier	•	
Financial	•	
Total (daily)	•	•
Periodical	•	•
Hours daily	•	•
Hours periodical (monthly)	•	•
Combined	•	•
El. journal	•	•
PC sale data	•	•

In the "Z" mode the department report, the cashiers report and the financial report are carried out within the total "Z" report.

## REPORTS CONTENTS

### Report menu

This function allows the user to choose from a list on the display and to execute any report that is available on the electronic cash register. This menu can be accessed after switching to X or Z mode by pressing the **MODE** key. A list of available reports with a description of their order number and the key that starts the report "Print - TL" will appear on the display.



Shifting between items can be **SKIFT** **UTBET EAN** done using the **SUMMA** **INBET VAG** or [RA] keys to switch to the next item and with the **UTBET EAN** key to go back to the previous item in the list. To execute a report, press **KONTANT**, the electronic cash register will then be ready for confirmation - **SUMMA** or cancel - **CL**.

*Notice:*

*Only reports that are available in the chosen mode appear in the reports list.*



---

## List of reports from the menu

Euro-2100TE

### X mode:

1. TOTALRAPPORT
2. PERIODISK RAPPORT
3. KASSo:RSRAPPORT
4. VGR RAPPORT
5. PLU RAPPORT
6. LAGERRAPPORT
7. SAMMANSTa:LLNING
8. KOMBINERAD RAPPORT
9. TIMRAPPORT DAG
10. TIMRAPPORT PERIOD.
11. TXT JOURNAL
12. BIN JOURNAL

### Z mode:

1. TOTALRAPPORT
2. PERIODISK RAPPORT
3. PLU RAPPORT
4. KOMBINERAD RAPPORT
5. TIMRAPPORT DAG
6. TIMRAPPORT PERIOD.
7. TXT JOURNAL

## Department report

When printing a full department report, only departments with non-zero sales are printed.

Department report is included in the daily and monthly report.

### Report contains:

- 1) Name of the department
- 2) Number of items sold in the department
- 3) Total value of the items sold in department
- 4) Total value of sales including all departments

In the "Z" mode it is possible to print the department report only within the total "Z" report. See chapter regarding total daily "Z" report.

## PLU report

Three different types of PLU reports can be printed: the individual PLU report, report of PLU range, and the full PLU report. Each of these types can contain the PLU number (depends on the report mode) and stock status according to the setting of second PLU flag.

When printing a PLU report, only PLUs with non-zero sales are printed.

### A PLU report contains:

- 1) Number of the PLU (selective according to the mode of report function calling)
- 2) The name of the PLU
- 3) Number of sold PLUs
- 4) Financial value of sold PLUs
- 5) PLU stock status (according to the setting of the second PLU flag)

The full PLU report prints also the total financial value of sales from the last reset. PLUs that were not activated are not printed.

The report also prints out overall informations about non-financial PLU movements (receive/hand out from stock, orders and inventories), total value and values for individual PLUs.

## PLU stock report

Euro-2100TE allows to print more types of stock level reports: stock level report of one PLU, stock level report of the range of PLUs and total stock level report.

Only stock of programmed PLUs (with non zero price) is printed in PLU stock report.

### Report contains:

1. PLU number (selective according to the mode of report function calling)
2. PLU name
3. Current PLU stock level

## Financial report

### The financial report contains:

- 1) Value of cumulative totals (grand totals) GT1, GT2 and GT3
- 2) Taxable amounts and taxes of all tax levels
- 3) Overall sales value
- 4) Overall sales value without tax
- 5) Value of total tax
- 6) Number and value of voids
- 7) Number and value of refunds
- 8) Number of drawer openings. This counter is incremented each time the drawer is opened from R or T mode
- 9) Number of printed duplicate receipts and their value. Only duplicate receipts from R mode are counted
- 10) Number of receipts and their value from training mode. Only purchase receipts from T mode are counted
- 11) Number and value of discounts
- 12) Number and value of add-ons
- 13) Number and value received by cash payment
- 14) Number and value received by cash in foreign currency (SEK)
- 15) Number and value received by check payment
- 16) Number and value received by credit card payment
- 17) Number and value received on accounts by cash
- 18) Number and value received on accounts by cash in foreign currency (SEK)
- 19) Number and value received on account by cheques
- 20) Number and value paid out by cash
- 21) Number and value paid out by cash in foreign currency (SEK)
- 22) Number and value paid out by cheques
- 23) Cash value in the cash drawer
- 24) Cash value in the cash drawer in foreign currency (SEK)
- 25) Cheque value in the cash drawer
- 26) Credit value in the cash drawer

None of the above categories with zero values will be printed (excepting tax informations). In the "Z" mode the financial report is printed only within of the total "Z" report. See chapter regarding total daily "Z" report.

---

## Cashier report

When printing the full cashiers report, only non-zero values will be printed.

### The cashier report prints:

- 1) The cashier's name
- 2) The number of sales transactions (number of customers) per cashier
- 3) Total sales value for each cashier
- 4) Total sales in cash for each cashier
- 5) Total sales in cash (foreign currency) for each cashier
- 6) Total sales in cheques for each cashier
- 7) Total sales in credit for each cashier
- 8) Total value of receive on stock for each cashier
- 9) Total value of hand out from stock for each cashier
- 10) Total value of orders for each cashier
- 11) Total value of inventories for each cashier

In the "Z" mode the cashier report can be printed only by means of the total "Z" report. See chapter regarding total daily "Z" report.

## Total daily "X" report

### Total "X" report contains:

- consecutive number of the total "Z" reports that have already been executed
- department report
- cashier report
- financial report

## Periodical "X" report

The periodical "X" report gathers financial data from the total "Z" reports in the course of longer time period (i.e. a week, a month, etc.). This report prints all financial data accumulated since the last periodical "Z" report.

## Total daily "Z" report

### The total "Z" report contains:

- consecutive number of the total "Z" report being executed on the machine
- department report
- cashier report
- financial report

After printing the memory contents of the total "Z" report, is added to the memory registers of the periodical report and counters of total daily "Z" report are then reset.

## Periodical "Z" report

The periodical "Z" report gets the data from the total "Z" reports in the course of a longer time period. It is usually printed weekly, monthly, or quarterly or as needed. After printing the memory contents of the periodic "Z" report, the memory is cleared.

## Hours daily report

### Hours daily report provides view of sales flow during the day and contains:

1. Hours summary
2. Number of sales and value of sales in current hours
3. Total value of all sales

Hours daily report must be performed always at the end of the day (otherwise there is cumulative value from more days). After hours daily report is printed in "Z" mode, values are added to the values of hours periodical report and counters are erased.

## Hours periodical report

Hours periodical report provides view of sales flow in current hours in total through whole month and contains:

1. Hours summary
2. Number of sales and value of sales in current hours
3. Total value of all sales

Hours periodical report is usually performed at the end of the month after hours daily report.

It is possible to perform it also in other period. Values of hours monthly report are erased after it is printed in "Z" mode.

## Combined report

A combined report prints out a daily and a PLU report together. The advantage of this report is that upon printing a daily report, the PLU report is printed and automatically deleted.



This way, sale information is followed at daily intervals.

If the electronic cash register is stopped during the printing of a receipt, the printing will be complete at the next start of the electronic cash register. If the electronic cash register is stopped during the printing of a PLU report, the PLUs that were printed on paper will be deleted, and the rest will remain intact. At the next start of the electronic cash register, the PLU report will be completed.

## Electronic journal and sale data

These two reports are described in separate chapters. The Electronic journal is automatically deleted after printing.

## How to print "X" reports

Switch the cash register into the "X" mode:  . Press any of the key combinations shown in table 5. 2. to print proper reports. The "X" report can be printed as many times as desired without influencing data in electronic cash register memory.

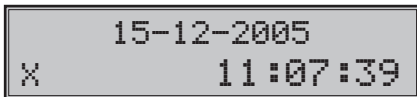

For "X" PLU report with PLU numbers press keys   and for "X" PLU stock level report with PLU numbers press keys  .

## List of reports from menu

### Euro-2100TE/Euro-200TE

#### X mode:

- |                   |                     |                         |
|-------------------|---------------------|-------------------------|
| 1. total report   | 5. PLU report       | 9. hourly report day    |
| 2. monthly report | 6. stock report     | 10. hourly report month |
| 3. cashier report | 7. financial report | 11. txt journal         |
| 4. DPT report     | 8. combined report  | 12. bin journal         |

**Z mode:**

- |                    |                        |
|--------------------|------------------------|
| 1. total report    | 5. hourly report day   |
| 2. monthly report  | 6. hourly report month |
| 3. PLU report      | 7. txt journal         |
| 4. combined report | 8. bin journal         |

**Table 5. 2. "X" reports.**

"X" report	Key operation
Cashier	SKIFT EXP \$
Financial	CHECK
Departments	department button (VGR)
Full PLU	PLU
Individual PLU	0 ... 9 RETUR PLU
PLU range	starting PLU number KR- finishing PLU number KR- PLU
Full PLU stock level	FEL PRIS
Individual PLU stock level	0 ... 9 PLU
PLU stock level range	starting PLU number KR- finishing PLU number KR- PRIS
Total (daily)	KONTANT
Periodical	SKIFT UTIBET EAK
Hours daily	KORT
Hours periodical (monthly)	FEL KORT
Combined	FEL KONTANT
El. journal with erasing	INBET VAG
PC sale data	EXP \$
Menu reports	MODE

### Samples of "X" reports

The cashier's report provides an overview of the activity of individual cashiers. The report provides a summary of the number of customers served by a particular cashier and the total receipts. This data permits rewarding the staff based on total receipts or productivity and intensity of work.

The department report provides a picture of the sales frequency of individual articles within a group of products. The cash register provides data concerning the number of items sold and turnover in the department, as well as the share of department sales as a whole.

***** X ***** CASSOSRAPPORT *****	
<b>Smith</b>	
TOTAL SALE	
4x	81.50
KONTANT	
4x	81.50
LGER IN	
1x	11.00
LGER OUT	
1x	5.00
BESTÄLLNING	
1x	11.00
INVENTERING	
1x	11.00

Hopkins	
TOTAL SALE	
5x	89.00
KONTANT	
3x	19.00
CHECK	
1x	45.00
KORT	
1x	25.00

***** X ***** * VGR RAPPORT *	
*****	
Groceries	
3.0000	93.60
Dairy	
6.0000	111.60
Stationery	
4.0000	124.80
VGR TOTAL:	330.00

PLU report provides the most exact preview of each item sales. Example of report on the right side is without listing the stock level and number of PLU. Example of report on the left side contains maximal available data of PLU report. Because this report provides most extended data, we recommend to use a PC with attached SW for programming of PLU, stock level control and for the sales preview print outs.

***** X ***** PLU RAPPORT *****	
<b>00001</b>	
Apple Cake	
6.0000	30.00
LAGER	99.000
<b>00002</b>	
Beef Soup	
2.0000	12.00
LAGER	100.000
<b>00003</b>	
Beef Steak	
4.0000	48.00
LAGER	100.000
<b>00004</b>	
Goulash	

2.0000	15.60
LAGER	100.000
<b>00005</b>	
Boiled Noodles	
9.0000	45.80
LAGER	100.000
<b>00006</b>	
Fruit Cup	
6.0000	12.00
LAGER	100.000
-----	
PLU FÖRSÄLJNING:	163.40
PLU LAGER IN:	11.00
PLU LAGER UT:	5.00
PLU BESTÄLLN:	11.00
PLU INVENTER:	11.00

***** X ***** PLU RAPPORT *****	
*****	
Apple Cake	
6.0000	30.00
Beef Soup	
2.0000	12.00
Beef Steak	
4.0000	48.00
Goulash	
2.0000	15.60
Boiled Noodles	
9.0000	45.80
-----	
PLU FÖRSÄLJNING:	151.40
PLU LAGER IN:	11.00
PLU LAGER UT:	5.00
PLU BESTÄLLN:	11.00
PLU INVENTER:	11.00

The total "X" report provides detailed sales information during the day. It contains sales information within departments, total sales, the cashier's share of sales, taxable revenue corresponding to the tax rate, the number of corrections and refunds, and the cash or check amounts in the drawer. Sales are separated from non-business transactions, i. e. received on accounts and payouts.

The "X" report is often used to check revenues and cash received when the operator changes during the working day. Management can obtain sales information at any time during a day.

The number of all total "Z" reports performed on the cash register is marked as Z1 and number of all periodical reports is marked as Z2.

15-12-2005  
Z 11:07:39

***** X *****	
TOTALRAPPORT	
Z1#	0000
VGR RAPPORT	
*****	
VGR01	
31.000x	175.40
VGR07	
3.000x	56.60
VGR TOTAL:	232.00
*****	
KASSÖRSRAPPORT	
*****	
<b>Smith</b>	
TOT.FÖRSÄLJNING	
20x	143.00
KONTANT	
6x	143.00
CHECK	
1x	11.00
RETUR	
1x	5.00
FELSLAG	
2x	11.00
ANNULLERA	
1x	11.00
<b>Hopkins</b>	
TOT.FÖRSÄLJNING	
5x	89.00
KONTANT	
3x	19.00
RETUR	
1x	-1.00
FELSLAG	
2x	45.00
ANNULLERA	
1x	25.00
*****	
SAMMANSTÄLLNING	
*****	
GT1	286.50
GT2	232.00
GT3	-54.50
MOMSSATS A	25.00%
MOMSSATS B	12.00%
BRUTTO A	16,90

BRUTTO B	12.00
NETTO A	12.00
NETTO B	0.00
MOMS A	114.40
MOMS B	215.10
TOTAL NETTO	16.90
TOTAL MOMS	
TOT.FÖRSÄLJNING	0
*****	
22x	
RABATT	0.00
0x	0.00
RETUR	
1x	232.00
FELSLAG	
2x	0.90
ANNULLERA	
1x	-0.50
LADÖPPNING	
OAVSLUTAD FÖRSÄLJNING	
KVITTKOPIA	
1x	-54.00
ÖVNINGSKVITTO	
3x	-32.00
KONTANT	
20x	-97.00
CHECK	
2x	162.00
KORT	
0x	25.00
INBETALT - KONTANT	
2x	0.00
UTBETAL - KONTANT	
2x	162.00
INBETALT - CHECK	
0x	
KONTANT	
	45.00
CHECK	
*****	
ÖVGRIT:	
SUMMA AVRUNDNING	

***** X *****	
PERIODISK RAPPORT	
Z2#	0002
Z1#	0002
*****	
VGR RAPPORT	
*****	
VGR TOTAL:	0.00
*****	
KASSÖRSRAPPORT	
*****	
SAMMANSTÄLLNING	
*****	
GT1	746.60
GT2	745
GT3	1.29
MOMSSATS A	25.00%
MOMSSATS B	12.00%
BRUTTO A	0.0
BRUTTO B	0.0
NETTO A	0.00
NETTO B	0.00
MOMS A	0.00
MOMS B	0.00
TOTAL NETTO	0.00
TOTAL MOMS	0.00
TOT.FÖRSÄLJNING	
0x	0.00
RABATT	
0x	11.00
MIX/MATCH RABATTER	
0x	0.00
RETUR	
0x	0.00
LADÖPPNING	
OAVSLUTAD FÖRSÄLJNING	0
KVITTKOPIA	
0x	0.00
ÖVNINGSKVITTO	
0x	0.00
KONTANT	
0x	0.00
CHECK	
0x	0.00
KORT	
0x	0.00
INBETALT-KONTANT	

0x	0.00
INBETALT-CHECK	
0x	0.00
OVGRIT:	
SUMMA AVRUNDNING	0.00

## How to print “Z” reports

Switch the cash register into the “Z” mode: **[3 MODE]**. Press the required keys according to the table 5.3. If a large number of PLUs is used, it is recommended that a computer will be used to print the PLU report.

During PLU report cash register allows by pressing **[FEL]** (REFUND) before pressing the key **[PLU]** to print of PLU number in a front of sales data.

To execute a PLU report without printing, press **[9 OFF] [9 OFF] [9 OFF] [9 OFF] [9 OFF] [PLU]**. PLU sales amounts will be deleted without printing.

**Table 5. 3. “Z” reports.**

“Z” report	Key operation
Full PLU	<b>[FEL] [PLU]</b>
Individual PLU	<b>[0] ... [9] [FEL] [PLU]</b>
PLU range	starting PLU number <b>[KR-]</b> finishing PLU number <b>[KR-] [PLU]</b>
Total (daily)	<b>[KONTANT]</b>
Periodical	<b>[SKIFT] [UTBET EAN]</b>
Hours daily	<b>[KORT]</b>
Hours periodical (monthly)	<b>[FEL] [KORT]</b>
Combined	<b>[INBET VÄG]</b>
PC sale data	<b>[EXP 5]</b>
Menu reports	<b>[MODE]</b>

## Samples of “Z” reports

The PLU report provides the most precise overview of the sales of each product. The sample report on the left side is without stock printouts and without PLU numbers (without pressing **[3]** (REFUND) before pressing **[PLU]** (PLU). The sample report on the right contains all information. As it provides the most detailed information, it is recommended that a computer be used for PLU programming, for running store records, will and for the sales reports print outs.

Number of all Total “Z” reports performed on the cash register is designated as Z1 and the number of all Periodical “Z” reports performed on the cash register is Z2.



```

***** Z *****
      PLU RAPPORT
*****
00001
Apple Cake
6.0000          30.00
LAGER          99.000
00002
Beef Soup
2.0000          12.00
LAGER         100.000
00003
Beef Steak
4.0000          48.00
LAGER         100.000
00004
Goulash

```

```

2.0000          15.60
LAGER         100.000
00005
Boiled Noodles
9.0000          45.80
LAGER         100.000
00006
Fruit Cup
6.0000          12.00
LAGER         100.000
-----
PLU FÖRSÄLJNING: 163.40
PLU LAGER IN:    11.00
PLU LAGER UT:    5.00
PLU BESTÄLLN:    11.00
PLU INVENTER:    11.00

```

```

***** Z *****
      PLU RAPPORT
*****
Apple Cake
6.0000          30.00
Beef Soup
2.0000          12.00
Beef Steak
4.0000          48.00
Goulash
2.0000          15.60
Boiled Noodles
9.0000          45.80
-----
PLU FÖRSÄLJNING: 151.40
PLU LAGER IN:    11.00
PLU LAGER UT:    5.00
PLU BESTÄLLN:    11.00
PLU INVENTER:    11.00

```



BÖRJAN PÅ JOURNAL	
10: 11: 17 Thu. 30-08-2007	
01.0002	KASSÖR 1
Apple Cake	A
1:5.00	-5.00
Beef Soup	B
1:6.00	-6.00
Beef Steak	A
1:12.00	-12.00
TAXABLE VAT 19.00%	
BRUTTO MOMS5%	21.00
NETTO MOMS 05%	5.67
MOMS 5%	3.33
TOTAL NETTO	5.67
TOTAL MOMS	3.33
TOTALT SEK	23.00
-----	
KONTANT SEK	23.00
-----	
10: 11: 38 Thu. 30-08-2007	
01.0003	KASSÖR 1

Beef Steak	A	
1:12.00	=12.00	
Goulash	A	
5:8.00	-40.00	
SUBTOTAL	52.00	
TAXABLE VAT 19.00%		
	52.00	
BRUTTO MOMS5%	70.00	
NETTO MOMS 05%	66.67	
MOMS 5%	3.33	
TOTAL NETTO	66.67	
TOTAL MOMS	3.33	
TOTALT SEK	70.00	
-----		
KONTANT SEK	70.00	
-----		
SLUT PÅ JOURNAL		

***** X *****	
FöRSÄLJNINGSDATA FÖR PC	
Början PÅ JOURNAL	
0: 30-08-2007	10: 14
KASSÖR 1	
4# 0000000000000000	
ECR1\$3	
P1: 1: 5.00-5.00; 0&-	
P2: 1: 6.00-6.00; 0&-	
P3: 1: 12.00-12.00; 0&-	
A: 17.00; 2.70	
B: 6.00; 0.00	
T: 23.00	
-----	
0: 30-08-2007	10: 14
KASSÖR 1	
5# 12345678ECR1\$2	
P3: 1: 12.00-12.00; 0&-	
P4: 5: 8.00-40.00; 0&-	
A: 52.00; 8.00	
T: 52.00	
-----	
FöRSÄLJNINGSDATA FÖR PC	
SLUT PÅ JOURNAL	

## How to erase text electronic journal

Electronic journal is the record of operations performed by the electronic cash register in binary/text form. One can erase the text electronic journal using following procedures:

Press **INSET VÄG** (SCALES) key in X-mode. The text data of electronic journal is printed and then cleared from electronic cash register memory.

If you want to erase the electronic journal in "Z" mode, fourth digit of the first extended flag has to be set to 1 in order to print and clear the text electronic journal after printing the daily "Z" report.

Upon setting the first extended system flag, the fourth parameter to "1" and the sixth parameter to "0", and upon pressing the key **KONTANT** in Z mode, the electronic journal will be printed automatically with the daily report.

If an external journal reader is connected to the electronic cash register, and the sixth parameter of the first extended system flag is set to "1", the journal will upon filling up to 90% or upon a daily report, be automatically transferred to the memory card of the journal reader. After successful transfer and storage, it will be deleted from the electronic cash register memory.

The text electronic journal can be also erased using the PC-ECR communication (after successful transfer to PC).

To avoid accidental clearing of the electronic journal, you are advised to authorise only a single cashier for „P" and "Z" modes and his/her login should be password protected. The password should be changed on a regular basis.

## PC sale data

This report contains all receipts stored in electrical form for their transfer to PC. These data are stored only if third extended flag is set up for their storage.

### Warning:

*Make sure you have sufficient tape in the electronic cash register prior printing the electronic journal. Before printing, open the rear cover and place the tape's end into the winding spool. Each receipt (sale) consists of receipt header, sold article data and financial data.*

Receipt header consist of three rows. The contents of each row are as follows:

**1st header row:**

1st value: sale type:

- 0 – normal sale,
- 1 – receive on stock,
- 2 – hand out from stock,
- 3 – order,
- 4 – inventory

2nd value: sale/movement date

3rd value: sale/movement time

**2nd header row:**

cashier name

**3rd header row:**

1st value: receipt number

2nd value: # document number

3rd value: ECR number

4th value: \$ number of articles in the sale

Sold article data are divided into the several rows. A single row contains following data:

1st value: Pxx: sale/handing out from stock of the PLU with number xx

rPxx: refund of the PLU with number xx

Dx: sale using the department no. x

rDx: refund using the department no. x

2nd value: amount sold/handed out

3rd value: unit price for the article

4th value: = total sale value of the article sold

5th value: bar-code type for given PLU & actual bar-code (if this doesn't fit into single row, bar-code is printed to a separate row)

Financial data are defined by presence of symbols in front of the numerical data, namely:

%+: surcharge in the sale in percent

%-: total discount in the sale in percent

V: total value of voidance in the sale

A: taxable value for first tax level

B: taxable value for second tax level

C: taxable value for third tax level

O: taxable value for the untaxable tax level (null tax level)

T: total sale value

Data that didn't occur are not printed.

---

## How to erase PC sale data

The contents of the electronic journal can be erased if one follows these procedures:

Conditions in "Z" mode: set second digit of third extended flag to 1. Press 5x  (DRAWER). This commences the clearing of PC sale data in electronic journal without printing it to the paper tape (if the corresponding electronic journal flag is set).

If the **electronic cash register** has an external journal reader connected and the sixth parameter of the first extended system flag is set to "1", the binary journal is automatically stored to the memory card of the journal reader upon filling up to 90% of the **electronic cash register** memory or during a daily report if the fourth parameter of the first extended system flag is set to "1".

If you press  (DRAWER) and the corresponding flag for PC data clearing from electronic cash register is set, then the **electronic cash register** will both print out the PC sale data and clear them from the electronic journal memory. If said flag is set to 0, then you'll be unable to clear the PC sale data from the electronic cash register.

To avoid accidental clearing of the electronic journal, you are advised to authorise only a single cashier for „P" and "Z" modes and his/her login should be password protected. The password should be changed on a regular basis.

The PC sale data can be also erased using the PC-ECR communication. There is no special protection against clearing the electronic journal via communications. The PC sale data are stored in the electronic journal memory only if the third digit of third extended flag is set to 1.



# ***EURO2A SOFTWARE***

The cash register Euro-2100TE is also delivered with the Euro2A software that makes programming, reporting and set-up for the Euro-2100TE user easier.

The software allows simple and easy editing and transfer of all possible electronic cash register data (ranging from setting of the system flags, through logos up to programming PLUs and departments), enables back-up of the electronic cash register data, processes sales data and many more useful functions.

The most up-to-date version of Euro2A software is available for you to download from company's web page, <http://www.elcom.eu>.



***OPTIONAL  
ELECTRONIC CASH REGISTER  
ACCESSORIES***

## Cash drawers

The cash register Euro-2100TE allows connection of majority of cash drawers that are based on solenoid opening mechanism (12-15V; 1,2A / 24V; 1,5A). The electronic cash register is equipped with cash drawer interface by default.

The cash drawer is connected to the electronic cash register via a cable that enables its automatic opening. The cable and the connector is easily detachable. Small establishments will surely welcome the possibility to place the cash drawer anywhere they wish and open it automatically using the electronic cash register.

Ask your authorised Euro-2100TE dealer on delivery and installation of cash drawers.



## Electronic scales

The cash register Euro-2100TE allows connection of multiple types of electronic scales. The scales are usually equipped with the serial interface that enables them to co-operate with the Euro-2100TE cash registers. It is possible to connect two scales in the same time to the Euro-2100TE. You can use electronic scales also, without connection to the Euro-2100TE. The electronic scales that are delivered with the cash registers Euro-2100TE are certified and equipped with a communication cable upon request.

Ask your authorised Euro-2100TE dealer on delivery and installation of electronic scales.



## Bar-code scanners

Interface for connecting bar-code scanners is a default feature of the cash registers Euro-2100TE. In case you wish to use bar-code scanners, this chapter will help you select the bar-code scanner suitable for your establishment. In any case, we recommend consulting this decision with your authorised Euro-2100TE dealer.

The bar-code scanner is connected to the electronic cash register via the standard RS-232 interface. The same interface must be available on the bar-code scanner. The electronic cash register supplies +5 V DC voltage to power the bar-code scanner. Both the electronic cash register and the scanner must be programmed appropriately in order to work together properly.

Metrologic bar-code scanners are the recommended option for the cash registers Euro-2100TE. Ask your authorised Euro-2100TE dealer on further information for bar-code scanners.



### Metrologic MS-5145 ECLIPSE

Scanning after pressing a trigger, hand scanner without stand, power supply 5 V, 72 lines/s, scanning range 140 mm, RS-232 interface (model 5145 R).

### Metrologic MS-6720

Combination of hand and stand scanner, great ergonomics, concentrated omnidirectional scanning mode, flexible handling, adjustable stand, easy programming, low cost, power supply 5 V, 1 000 rows/s, maximum scanning range 205 mm.



### **Metrologic Orbit MS-7120**

Multidirectional, quick, presentable laser bar-code scanner. It's equipped with holographic scanning technology for bar-codes. HoloPrism VLD technology allows focusing of rays in very large scanning field depth (0-215 mm). The design is directed at use in limited space. Orbit is ideal for small stores. Its unique shape allows this scanner to be also used as a hand scanner for large packages. The scanning head can be vertically tilted up to 30 degrees. Power supply is 5 V, 1,200 rows/s, RS-232 interface available.

### **Metrologic MS-9520 Voyager**

Handheld laser scanner, hand and stand use. Row scanning mode, easy programming, scanning speed 72 rows/s, scanning range 205 mm, power supply 5 V, RS-232 interface (model 9520 R).

Ask your authorised Euro-2100TE dealer on further information for scanner types not mentioned here.

### **External keyboard**

There are multiple types of external keyboards available for the cash register Euro-2100TE.

The first type of external keyboard is the EK-3000 keyboards that ideally complement the system in retail, since their use is easy to learn and quick. The keys are fully programmable and of course it's possible to easily replace the key labels. Every key on a EK-3000 keyboard can sustain up to 50 million strokes which is 15 times more than a PC keyboard can sustain. The logging in of cashiers is made easy thanks to the RF reader, which is an optional accessory of the EK-3000.



Another advantage over a PC keyboard is the programmable key layout, along with pleasing design. The keyboard covers are manufactured in attractive green or blue, in grey or in wood imitation. The EK-3000 can also be connected to a PC or any electronic device that is equipped with PS/2 port. The Elcom keyboard allow our customers to express their uniqueness and identity.

The second option is the standard PS/2 PC keyboard.

### **Optional internal battery**

The design of Euro-2100TE makes it easy to use the electronic cash register as portable and take it outdoors. It's easily portable and with help of internal battery it can be used as back-up electronic cash register in case of a power black-out. Minimum battery life is eight hours.

### **External battery box**

By using this device, energy can be supplied to the electronic cash register for up to 8 hours of use. The time depends on the operations that are executed on the electronic cash register (more/less print and account).

### **External journal downloader**

The electronic cash register internal memory is able to store text and binary journal in limited amount. With help of external journal downloader, you are able to download and store journal on SD, SDHC or MMC card without need of connecting computer or any other device to electronic cash register. The Journal Downloader is able to replicate serial COM port, function which provides connectivity of serial device like scanner or scale to electronic cash register.

## **LAN connection options**

The possibility to connect the cash register Euro-2100TE into an Ethernet network is offered by the RS-232/Ethernet converter.

What is to be gained from this? You can save lot of finances, since this will enable you to create single electronic cash register network that can be composed from various types of Elcom cash registers.

## **New features of Elcom cash registers**

The GSM communication widens the possibilities for ECR/PC data interchange. Detailed and quickly obtained data are crucial for proper management in retail. This modern technology will greatly facilitate connection with any of the cash registers Euro-2100TE.

Connectivity of the CleanCash and external journal reader provides an optimal solution to legal and usability requirements.

# ***HELPFUL ADVICE***

## INFORMATION AND ERROR MESSAGES

If it is necessary to inform the operator on the current status of the electronic cash register, or the electronic cash register is in error state, the error messages shown in table 8.1 are displayed.

**Figure 8.1 - List of electronic cash register messages**

Message	Meaning
100%	No external power supply is connected. The power supply is internal accumulator. The percentage value indicates the status of internal accumulator charge.
ADD ON - DISCOUNT LIMIT OVER	Add on or discount amount limit over. Check the system flags.
ADD ON - DISCOUNT TO NEGATIVE VALUE	Add on or discount to negative amount disabled.
AMOUNT DUE	Information about amount that has to be paid for sale finish.
BAR CODE DUPLICATE	Bar code is assigned to another PLU.
CARD NOT ACCEPTED	Credit card not accepted during EFT terminal payment.
CODE SORTING	electronic cash register sorts programmed bar codes.
COMMUNICATION ERROR	Communication error between electronic cash register and PC or EFT terminal.
CONTINUE ON SALE	electronic cash register is ready to continue on sale.
CREDIT CARD PAYMENT LIMIT OVER	Credit card payment limit is over.
DATE ERROR	Incorrect date entry.
DATE REVERSE ORDER	Incorrect date entry.
DECIMAL PLACES LIMIT OVER	Second system flag disables sale with more decimal places.
DPT INACTIVE	Sale through this DPT is forbidden.
DUPLICATE PRINT	The printing of duplicate of last receipt.
ECR – PC	The communication between electronic cash register and PC is running.
ECR AFTER REPORT	No sale from daily (total) report execution.
ENTER SERVICE CODE	Unblocking programming mode can be done only by entry of service code.
ENTER THE AMOUNT OF CUSTOMER CASH	Enforced entry of customer cash before sale finishing.
ENTRY ERROR	Unexpected entry. Incorrect sequence of keys pressed.
FINISH PURCHASE	Maximum count of PLU in a sale has been reached (100), or maximum count of lines in one receipt has been reached.
FLAG ERROR	Incorrect flag entry.
FORBIDDEN ENTRY OF RETURNABLE PACKS	Operation of bottles not can be performed.
GT LIMIT OVER EXECUTE REPORTS	Grandtotals reached the maximum amount. Execute daily (total) and periodical report. Call your service technician.
GT NEGATIVE VALUE	Performed operation caused negative Grandtotal.
HEAD OVERHEAT	Information on the thermal head overheat. Wait a moment until normal condition returns.
HEAD UP POSITION	The thermal head is in an up position. Move it down to enable printing.
ILLEGAL EURO PHASE	Access is not possible to this Euro phase.
ILLEGAL INVASION TO EPROM	Call for service!
ILLEGAL PAYMENT	This way of payment is not possible.

ILLEGAL TAX RECEIPT	Receipt data has not been counted to electronic cash register financial data. Illegal receipt.
INACTIVE TAX	Tax level cannot be assigned to DPT or PLU.
INCORRECT MODE	Incorrect mode. Finish operation before mode switching.
INVALID RECEIPT	Receipt data is not counted to electronic cash register financial data.
ITEM NOT SOLD	PLU not sold.
MAX. STOCK/LIMIT OVER	Stock amount reached max. 999 999,999.
MULTIPLICATION/LIMIT OVER	Multiplication reached max. amount 10 000.
NOT PROCESSED BARCODE	Bar code not processed during sale.
OPEN PRICE INACTIVE	DPT (PLU) flag prevents entry of price from keyboard.
OPERATION CAUSED/NEGATIVE STOCK	PLU flag prevents entry to negative stock.
PAPER MISSING	Paper is missing in the printer.
PARAMETER ERROR	Incorrect setting of electronic cash register parameters.
PASSWORD	It is necessary to cashier login.
PASSWORD DUPLICATE	Password is assigned to another cashier already.
PAYMENT NOT ACCEPTED	Payment not accepted during EFT terminal payment.
PERFORM DAILY REPORT	Perform daily (total) report.
PERFORM MONTHLY REPORT	Perform periodical report.
PLU INACTIVE	PLU flag disables the sale of this PLU.
PRESS KEY SUBTOTAL	Press subtotal.
PRICE HALO LIMIT OVER	HALO limit over. Check the flags of DPT or PLU.
PRICE MISSING	Programmed price is zero.
PROCESSING ERROR	Error occurs during payment through EFT terminal.
PROGRAMMED PRICE/INACTIVE	DPT or PLU flag setting prevents use of programmed price.
RECHARGE BATTERY	It is necessary to connect external adapter.
SALE	Normal sale mode. Data on receipt in R mode are counted to GTs.
SALE AMOUNT/LIMIT OVER	Sale amount reached maximum. Terminate the sale.
SCALES DISCONNECTED	Electronic scales are disconnected, or no data has been read.
SPLIT PRICING/DENIED	PLU flag disables split pricing.
STANDBY	Standby mode. Exit the "standby" mode by pressing the  (MODE) button.
TAX LEVEL INACTIVE	DPT or PLU is assigned to inactive tax level.
TAX LEVEL/LIMIT OVER	Particular tax level amount over limit from the last daily report. Perform daily (total) report.
UNAUTHORIZED ACCESS	Cashier has no authorization to enter into this mode.
UNKNOWN CODE	Bar code is assigned to no PLU.
WAIT PLEASE	electronic cash register executes operation that takes a longer time.
OFF&ON ECR	To correct the problem turn off and turn on electronic cash register.
REFUND CNT.LIMIT	Maximal amount of refunded items is reached. Perform daily (total) report.
CNT.LIMIT OVER	Maximal amount of discounts is reached. Perform daily (total) report. „DISC
Unknown batt. state	Battery status unknown, recharge the battery.
LowBAT, finish sale	It is shown when receipt it printing, when it is needed bigger power input. Connect electronic cash register to power supply with external adapter.

Helpful advice

Very low battery	Connect electronic cash register to power supply with external adapter.
RESET CODE	Memory can be damaged. Call for service.
Battery checking	Checking battery condition.
Perform PLU report	While switching to the second Euro phase. Perform „Z“ PLU report.
Perform DPT report	While switching to the second Euro phase. Perform „Z“ DPT report
Perform clerk report	While switching to the second Euro phase. Perform „Z“ cashiers report.
BAD PSW	Password was not find in list of cashiers passwords.
Perf. hour.rep.daily	Message is shown when you trying to perform Hours periodical report without Hours daily report performed.
Perf.hour.rep.period	Message is shown when you trying to switch into the second Euro phase without Hours periodical report performed.
JOURNAL CONTENT FULL PRINT JOURNAL	Print out the electronic journal to release occupied memory.
JOURNAL DAMAGED	PC data in electronic cash register memory are damaged.
JOURNAL FULL FOR 80%	Journal is full up to 80%.
JOURNAL FULL FOR 90%	Journal is full up to 90%.
JOURNAL ALMOUST FULL	Journal is full up to 95, it is necessary to print the journal as soon as possible, since after journal fills up to 98, it is impossible to start another receipt.
TEAR OFF RECEIPT AND PRESS SUBTOTAL KEY	Get ready for electronic journal printing.
DON'T TURN OFF ECR! UPDATING..	Proceeding of software update, don't stop the electronic cash register !
CC COMM.ERROR XX	Failure of communication between electronic cash register and CleanCash. XX represents internal failure number of communication. The device is not connected or the communication settings are not correct. If this message will be displayed after checking the settings and communication cable, contact service.
CC FELAKTIGT KASSAID	Incorrect electronic cash register number (from 3rd system flag). Synchronize the electronic cash register number from electronic cash register with that from CleanCash.
INCORRECT POS ID	
CC FATAL ERROR	Failure of CleanCash, call service.
CC upptagen. Försöka igen?	The CleanCash is preceding data synchronization which is not allowing responding the electronic cash register request. Wait until the CleanCash will
CleanCash is busy. Repeat?	
CC FUNGERAR EJ	CleanCash failure, call service.
CC NOT OPERATIONAL	
CC INTERNT FEL	CleanCash failure, call service.
CC INTERNAL ERROR	
CC OKÄNT FEL	Unknown error message send from CleanCash, call service.
CC UNKNOWN ERROR	



CC COMM.SEQUENCE ERR	Internal failure of communication with CleanCash, call service.
ECR <-> CC	Proceeding of electronic cash register and CleanCash data transfer.

## **WHAT TO DO IN CASE OF POWER FAILURE?**

### **Power failure**

This part is important only for registers that operate without the built-in accumulator.

If you have used the cash register and a power failure occurs, it is necessary:

- to switch the cash register off
- after electric power recovery switch the cash register on
- if the register displays the text Continue on Sale it is necessary to complete the purchase and compare the resulting sum with the total of registered items within the purchase; if one of the items has not been added to the total sum of the purchase but it was sold to the customer it is necessary to register it additionally.

### **Failures of electronic cash register as a result of interference in power network**

Accidental failures of electronic equipment are frequently caused by the power network or by electromagnetic interference. In case of intensive interference in your working area, or in case of over or under voltage, installation of protective devices can help significantly. Ask your authorised dealer or service technician for help.

### **Signalization of internal accumulator conditions**

The status of internal accumulator charge defines the percentage value in the upper left corner of the cashier display. This percentage value informs also that power supply of the electronic cash register is internal accumulator (the external adapter is not connected). In the case the charge is low (low percentage value) the electronic cash register displays the text Low BAT., finish sale for a short time and peeps alerting tone.

If the internal accumulator is very discharged and you want to charge it by the external adaptor, first of all be sure that electronic cash register is turned off, then connect the external adapter for at least 15 minutes (electronic cash register is off). The internal accumulator is charging even the electronic cash register is turned off.

#### **Care of internal battery:**

- a complete battery charge takes 4 to 5 hours.
- we suggest to charge a battery to 100 % and use it till cash register starts to signalize the battery charge requirement. Repeat this process three times at least (it elongates an endurance of the battery).
- we suggest to change the battery in case of the battery decrease, e. g. shorter work cycle of the electronic cash register after a battery charge.





## **SELF TESTS**

Self tests of the Euro-2100TE cash register permit the checking of its functionality simply and quickly. Self testing permits the automatic checking of the functionality of electronic circuits, display segments, keyboard buttons, communication ports and the printer.

## Self-test of the electronics and display

By executing this test, characters are gradually lightened on and off on the both displays.

Procedure for running the self-test of the electronics and display:





- 1) Switch electronic cash register into the "P" mode: .
- 2) Press    on the keyboard.
- 3) Press the  (MULTIPLY) button.

Display test end is announced by a beep. You can continue testing other parts of register.

## Self-test of the printer

The self-test of the printer prints the identification data of the Euro-2100TE on the receipt and journal. It prints the program version number, cash register configuration (number of departments, number of PLUs), serial interface and FM enable/disable information and the complete character set in standard size with related hexadecimal codes.

Procedure for running the self-test of the printer:







- 1) Switch electronic cash register into the "P" mode: .
- 2) Press    on the keyboard.
- 3) Press the  (MULTIPLY) button.

The printer test end is announced by a beep. You can continue in testing of other parts of register.

## Self-test of the keyboard

The self-test of the keyboard displays the position, hexadecimal code and name after pressing a key. The test checks functionality of the register keys.







Procedure for running self-test of keyboard:

- 1) Switch electronic cash register into the "P" mode: .
- 2) Press    on the keyboard.
- 3) Press the  (MULTIPLY) button.
- 4) Press the individual buttons one after another and check the values on the display.
- 5) To finish the test press the  (TOTAL) button.

If the key is functional, its position, code and name will appear on the display. Press the  (TOTAL) button to finish the keyboard test.

## Self-test of the keyboard II.

This second self-test of the keyboard evaluates the consecutive pressing of keys. If the electronic cash register also contains an optional programmable keyboard, the self-test will also evaluate this keyboard. If the keys are pressed in the exactly defined order shown in Figure 8. 1. (8. 2), and the keyboard and its control circuits are working fine, the test is finished successfully.

- 1) Switch electronic cash register into the "P" mode: .
- 2) Press    on the keyboard.
- 3) Press the  (MULTIPLY) button.
- 4) Press the individual buttons one by one following the direction shown in Figure 8. 1. (8. 2).
- 5) To finish the test press the  (TOTAL) button.

## Keyboard test in P Mode

The standard keyboard test **3** **2** **0** **⊗** will work with the default keyboard layout. To check the actual programmed key functions, the test **3** **2** **0** has to be used which will display the key codes. This test can be cancelled with the **⊗** (TOTAL) or **⊗** (MODE) key.

## SERVICE CODES OF THE ELECTRONIC CASH REGISTER

Codes accessible in the X-mode, press **2** **⊗** (MODE) to access them:

- **8** **0** **1** **⊗** (MULTIPLY)

Checking for available journal memory.

- **8** **0** **2** **⊗** (MULTIPLY)

Switching the PLU number printing on the receipt (this can be also done with the help of the seventh extended system flag, first parameter).

- **8** **0** **3** **⊗** (MULTIPLY)

Switching of the printing of the time on the receipt (can be set in an extended system flag).

- **8** **4** **0** **⊗** (MULTIPLY)

Switch ON/OFF the printing of a communication message upon communication with PC.

